

SOFIA PROFESSIONAL 36"







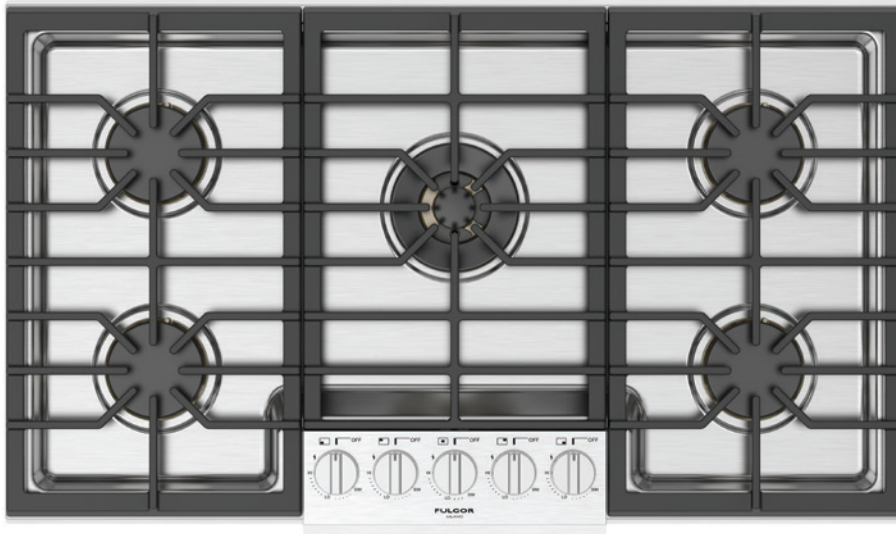

CODE ID

36" PROFESSIONAL PRO GAS COOK TOP

F6PGK365S1



-  Knob control with back light system
-  1 Center Dual Burner
-  4 Stack Burner
-  Heavy Duty Grates
-  Continuous Grate Surface
-  Heavy Duty Control Panel



COOKING SURFACE

3 Heavy duty continuous cast iron grates
Heavy Gauge 304 Stainless Steel Burner Bowl
1 Solid Brass Dual Flame Burner with 20.000 BTU Max (NG)
4 Solid Brass Stacked Burners with 15.000 BTU Max (NG)
Backlit Control Knob indicates burner operation (White)
Backlit Control Knob indicates residual heat (Red)
Heavy duty control panel
Large cooking area
Full pot stability
Natural Gas (LP Convertible)

OPTIONAL ACCESSORIES

FMWOK Wok ring
FMSIM Simmer plate

SOFIA

36" PROFESSIONAL PRO GAS COOK TOP

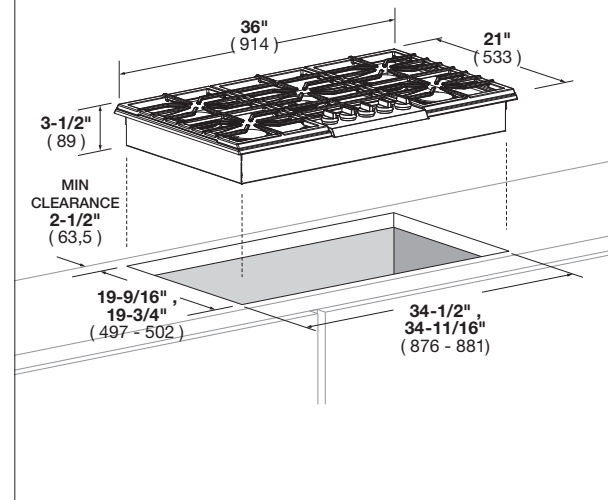
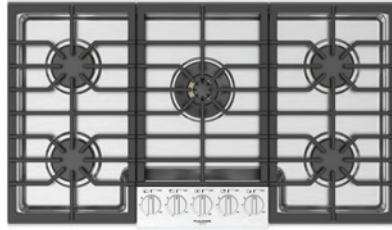

CODE ID	F6PGK365S1 - 36" PROFESSIONAL PRO GAS COOK TOP	
Series and Finish	600 Series - Stainless Steel	
CONTROL PANEL		
Control Type	Knobs	
COOKTOP		
Type	GAS (NG or LP)	
Cooking Surface	Matte Black Enamel	
GAS COOKTOP FEATURES		
Electric Re-ignition system	•	
Flame-out sensing	•	
Dual Crown Brass Burner	•	
Simmer Plate	Optional	
Small Pot Insert (for single burners only)	Optional	
Wok Ring (for dual burner only)	Optional	
Heavy Duty Cast Iron Grates	3	
Cooking Zones	5	
Brass Burners types	All Brass Dual Flame/Simmer Burner	
Power (Max/Min) (Front-L)	15000 (BTU/h) - 4400W / 1300 (BTU/h) - 382W	
Power (Max/Min) (Rear-L)	15000 (BTU/h) - 4400W / 1300 (BTU/h) - 382W	
Power (Max/Min) (Front Center)	20000 (BTU/h) - 5880W / 750 (BTU/h) - 220W	
Power (Max/Min) (Rear-R)	15000 (BTU/h) - 4400W / 1300 (BTU/h) - 382W	
Power (Max/Min) (Front-R)	15000 (BTU/h) - 4400W / 1300 (BTU/h) - 382W	
DIMENSIONS/WEIGHT		
Overall dim - Width	36"	(914 mm)
Overall dim - Height	4 - 5/8"	(118 mm)
Overall dim - Depth	21"	(533 mm)
Cut-out - Width (min - max)	34 - 1/2" , 34 - 11/16"	(876 mm) - (881 mm)
Cut-out - Height (min)	3 - 3/8"	(87 mm)
Cut-out - Depth (min - max)	19 - 9/16" , 19 - 3/4"	(497 mm) - (502 mm)
Gross Weight	73 lbs	(33.2 kg)
POWER / RATINGS (120 V, 60 HZ)		
Amps	0.1A	
Max Power	80000 (BTU/h) - 23480W	
Power Cable	Nema 5-15P	
INSTRUCTIONS FOR USE		
Use & Care Manual / Installation Manual	English / French / Spanish	