

---

**Porter&Charles**

**CI76V**

**EN**

**INDUCTION HOB**

**INSTALLATION AND OPERATING INSTRUCTIONS**

---

## CONTENTS:

Safety Warnings .....	3
Description of the appliance.....	5
Cooking surface and control panel of heaters.....	5
Operation of the appliance.....	7
Switching the appliance on and off.....	7
Switching the cooking-zones on and off.....	7
Smart Pause .....	7
Residual heat indicator.....	8
Safety switch off function.....	9
Child Lock.....	9
Key Lock .....	9
Timer function (*optional).....	10
Buzzer .....	11
Boost Function .....	11
Hints and tips.....	12
Installation of the appliance.....	14
Installation safety.....	14
Fitting the cooktop into a worktop.....	14
Making an electrical connection.....	16
Electrical connection diagram.....	17

## SAFETY WARNINGS

READ THESE INSTRUCTIONS CAREFULLY AND COMPLETELY BEFORE USING YOUR APPLIANCE, AND KEEP IT IN A CONVENIENT PLACE FOR REFERENCE WHEN NECESSARY.

THIS MANUAL IS PREPARED FOR MULTIPLE SIMILAR COOKTOPS. YOUR APPLIANCE MAY NOT HAVE SOME OF THE FEATURES THAT ARE EXPLAINED IN THIS MANUAL. REFER TO THE MODEL THAT HAVE FIGURES, WHILE YOU ARE READING THE OPERATING MANUAL.

### General Safety Warnings

- This appliance can be used by children aged from 8 years and above and persons with reduced physical, sensory or mental capabilities or lack of experience and knowledge if they have been given supervision or instruction concerning use of the appliance in a safe way and understand the hazards involved. Children shall not play with the appliance. Cleaning and user maintenance shall not be done by children without supervision.
- **WARNING:** The appliance and its accessible parts become hot during use. Care should be taken to avoid touching heating elements. Children less than 8 years of age shall be kept away unless continuously supervised.
- **WARNING:** Unattended cooking on a cooktop with fat or oil can be dangerous and may result in fire. **NEVER** try to extinguish a fire with water, but switch off the appliance and then cover flame e.g. with a lid or a fire blanket.
- **WARNING:** Danger of fire: do not store items on the cooking surfaces.

## SAFETY WARNINGS

- **WARNING:** If the surface is cracked, switch off the appliance to avoid the possibility of electric shock.
- For induction cooktops, metallic objects such as knives, forks, spoons and lids should not be placed on the cooktop surface since they can get hot.
- For induction cooktop, after use, switch off the cooktop element by its control and do not rely on the pan detector.
- For cooktops incorporating a lid, any spillage should be removed from the lid before opening. And also the cooktop surface should be allowed to cool before closing the lid.
- The appliance is not intended to be operated by means of an external timer or separate remote-control system.
- Do not use harsh abrasive cleaners or sharp metal scrapers to clean the cooktop glass and other surface since they can scratch the surface, which may result in shattering of the glass or damage to the surface.
- Do not use steam cleaners for cleaning the appliance.

2

## SAFETY WARNINGS

- Your appliance is produced in accordance with all applicable local and international standards and regulations.
  - Maintenance and repair work must be made only by authorized service technicians. Installation and repair work that is carried out by unauthorized technicians may endanger you. It is dangerous to alter or modify the specifications of the appliance in any way.
  - Prior to installation, ensure that the local distribution conditions (nature of the gas and gas pressure or electricity voltage and frequency) and the requirements of the appliance are compatible. The requirements for this appliance are stated on the label.
  - **CAUTION:** This appliance is designed only for cooking food and is intended for indoor domestic household use only and should not be used for any other purpose or in any other application, such as for non-domestic use or in a commercial environment or room heating.
  - All possible security measures have been taken to ensure your safety. Since the glass may break, you should be careful while cleaning to avoid scratching. Avoid hitting or knocking on the glass with accessories.
  - Ensure that the supply cord is not wedged during the installation. If the supply cord is damaged, it must be replaced by the manufacturer, its service agent or similarly qualified persons in order to prevent a hazard.
- ### Installation Warnings
- Do not operate the appliance before it is fully installed.
  - The appliance must be installed by an authorized technician and put into use. The producer is not responsible for any damage that might be caused by defective placement and installation by unauthorized people.
  - When you unpack the appliance, make sure that it is not damaged during transportation. In case of any defect; do not use the appliance and contact a qualified service agent immediately. As the materials used for packaging (nylon, staplers, styrofoam...etc) may cause harmful effects to children, they should be collected and removed immediately.
  - Protect your appliance against atmospheric effects. Do not expose it to effects such as sun, rain, snow etc.
  - The surrounding materials of the appliance (cabinet) must be able to withstand a temperature of min 100°C.
- ### During usage
- Do not put flammable or combustible materials, in or near the appliance when it is operating.
  - Do not leave the cooker while cooking with solid or liquid oils. They may catch fire on condition of extreme heating. Never pour water on to flames that are caused by oil. Cover the saucepan or frypan with its cover in order to choke the flame that has occurred in this case and turn the cooker off.
  - Always position pans over the centre of the cooking zone, and turn the handles to a safe position so they cannot be accidentally knocked.
  - If you will not use the appliance for a long time, switch it off.
  - Make sure the appliance control knobs are always in the "0" (stop) position when it is not used.
- ### During cleaning and maintenance
- Always turn the appliance off at the main control before operations such as cleaning or maintenance.
  - Do not remove the control knobs to clean the control panel.

**TO MAINTAIN THE EFFICIENCY AND SAFETY OF YOUR APPLIANCE, WE RECOMMEND YOU ALWAYS USE ORIGINAL SPARE PARTS AND TO CALL ONLY OUR AUTHORIZED SERVICE AGENTS IN CASE OF NEED.**

EURO PARTS:1800.678.8352

3

## DESCRIPTION OF THE APPLIANCE

Dear Customer,  
Please read the instructions in this user guide before using the cooktop and keep it for future reference.

### Cooking Surface for 4 zones:

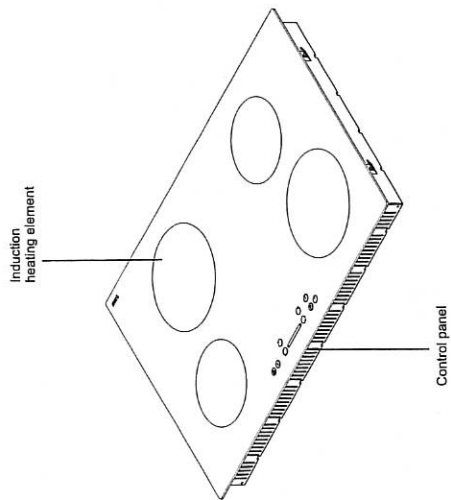

4

### Control Panel for 4 zones :

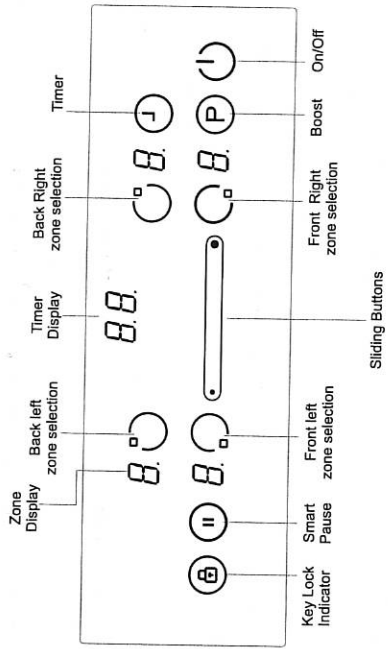

5

## OPERATION OF THE APPLIANCE

Use the induction cooking zones with suitable cookware.



After mains voltage is applied, all displays come on for a moment. Following this, the cooktop is in the *stand-by mode* and it is ready for operation.

The cooktop is controlled with electronic sensors which are operated by touching the related sensors. Each sensor activation is followed by a sound signal (**buzzer**).

### Switching the appliance on:

Switch the cooktop on by touching ON/OFF key . All zone displays show a static "0" and the bottom right dots blink. (If no cooking-zone is selected within 20 seconds, the hob will automatically turn off.)

### Switching the appliance off:

Switch the cooktop off at any time by touching . ON/OFF key  always has priority in the switch off function.

### Switching the cooking-zones on:

Touch the *zone selection* key you wish to cook on. There is a static dot indication on the selected zone display and the blinking dot on all other displays extinguish.

For the selected zone, you can set the heat level by touching the Sliding Buttons from low to high(left to right).  The element is now ready to cook on. For quickest boil times, select desired cooking level and then touch the P key to activate Boost function.

### Switching the cooking-zones off:

Select the element you want to switch off by pressing the *zone selection* key. Using the  Sliding Buttons from high to low(right to left) turn the temperature down to "0". (Also using the right and left of the slider buttons simultaneously turns the temperature to "0").

If the cooking zone is hot, "H" will be displayed instead of "0".

### Switching all cooking-zones off:

To turn all the cooking zones off at once, touch the  key. In the *stand-by mode*, an "H" appears on all cooking zones which are hot.

### Residual heat indicator:

Residual heat indicator indicates that the glass ceramic has a dangerous touch temperature in the circumference of a cooking zone.

After switching off the cooking zone, the respective display shows "H" until the assigned cooking zone temperature is in an uncritical level.

### Smart Pause

Smart Pause, when activated, reduces the power of all burners that have been switched on. If you then deactivate the Smart Pause, the heaters will automatically return to the previous level.

If the Smart Pause is not de-activated, the cooktop will turn off after 30 minutes.

Touch  to activate Smart Pause. The power for the activated heater(s) will reduce to level 1 and "1" will appear at all displays.

Touch  again to deactivate Smart Pause. "1" will disappear and the heaters will now run at the level previously set.

#### Safety switch off function:

Every cooking zone will be switched off after a defined maximum operation time if the heat setting is not modified. Every change in the cooking zone puts back the maximum operation time to the initial value of the operating time limitation. The maximum operation time depends on the selected temperature level.

Heat setting	Safety switch off after
1 - 2	6 Hours
3 - 4	5 Hours
5	4 Hours
6 - 9	1,5 Hours

#### Child Lock:

After switching on the control, the child lock function can be activated. To activate the child lock, simultaneously press the right and the left of the slider button and then press the right of the slider button again. "L" meaning LOCKED will appear in all zone displays and the control can not be changed. (If a cooking zone is in the hot condition, "L" and "H" will be displayed in alternation.)

The cooktop will remain in a locked condition until it gets unlocked, even if the control has been switched off and on.

To deactivate the child lock, first turn on the cooktop. Simultaneously press the right and the left of the slider button and then press left of slider button again. "L" will disappear in the display and the cooktop will be switched off.

#### Key Lock

Key lock functionality is for blocking and set the appliance into a save mode during operation. Touch modifications for example raising e heat settings and others should not be possible. It is only possible to switch the appliance off.

The lock function is active, if the Key Lock button  is pressed for at least 2 sec. This operation is acknowledged by a buzzer. After successful operation of more than 2 sec, the Key Lock indicator flashes and the heater is locked.

#### Timer function (\*optional):



The timer function is realized in two versions:

##### Minute minder timer (1..99 min):

The minute minder timer can be operated if the cooking zones are switched off. The timer display shows "00" with a blinking dot.

Use the Timer Sliding Buttons  to increase/decrease the time. Adjustment range is between 0 and 99 minutes. If there is no operation in 10 seconds, the minute minder timer will be set and the blinking dot will disappear. After the timer is set, the time runs down according to the adjustment.

When the time is over, a signal sounds and the timer display blinks. The sound signal will be stopped automatically after 30 second and/or by operating any key.

The minute minder timer can be changed or switched off any time by using the Timer Sliding Buttons . Switching off the hob by touching  at any time will also switch off the minute minder timer.

##### Cooking zone timer (1..99 min):

When the hob is switched on, an independent timer can be programmed for every cooking zone.

Select a cooking zone, then select the temperature setting and finally activate the *timer setting* key , the timer can be programmed as a switch off function for a cooking zone. Four LEDs are arranged around the timer. These indicate for which cooking zone the timer has been activated.

10 seconds after the last operation, the timer display changes to the timer that will run out next (in case of programming more than 1 cooking zone).

## HINTS AND TIPS

When the timer has is complete, a signal sounds and the timer display shows "00" statically, the assigned cooking zone timer LED blinks. The programmed cooking zone will be switched off and the "H" will be displayed if the cooking zone is hot.

The sound signal and the blinking of the timer LED will STOP automatically after 30 second and/or by operating any key.

### Buzzer :

While the cooktop is in operation, the following activities will be signalled by means of a

buzzer:

- Normal key activation with a short sound signal
- Continuous operation of keys over a longer period of time (10 seconds) with a longer, intermitten sound signal.

### Boost Function :

A cooking zone has to be selected, cooking level set to „desired cooking level" and P(Boost) key has to be pressed again.

Boost-Function can be activated if the induction module accepts the setting on this cooking zone if Boost Function is actived a „P" is displayed on the corresponding display.

Activating the booster can exceed the maximum power for the appliance and the intagrated power management will be activated .

The necessary power reduction is shown by blinking of the corresponding cooking zone display. Blinking is active for 3 sec. and allows further adaptations of the settings before power reduction.

### Cookware

- Use thick, flat, smooth bottomed cookwares that are the same diameter as the element. This will help reduce cooking times.
- Cookware made of steel, enamelled steel, cast iron and stainless steel (if appropriately abelled by the manufacturer) will give you the best results.
- Cookware made of enamelled steel or aluminium or copper bottoms can cause a metallic residue to remain on the hob. If left, this becomes difficult to remove. Clean the hob after every use.
- Cookware is suitable for induction if a magnet sticks to the bottom of the cookware.
- Cookware must be placed centrally on the cooking zone. If it is not placed correctly, is displayed.
- When using certain pans, you may get various noises from the pans, this is due to the design of the pans and does not effect the performance or safety of the hob.

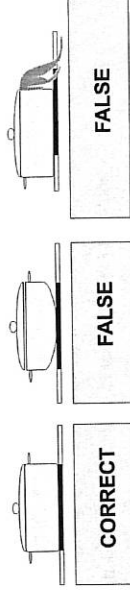

### Energy saving

- Induction cooking zones adapt automatically to the size of the cookware bottom up to a certain limit. However the magnetic part of the cookware bottom must have a minimum diameter depending upon the size of the cooking zone.
- Place the cookware on the cooking zone before it is switched on. If it is switched on before putting any cookware, the cooking zone will not operate and the control display shows.
- Use a lid to reduce cooking time.
- When liquid comes to the boil, reduce the temperature setting.
- Minimise the amount of liquid or fat to reduce cooking times.
- Select the proper temperature setting for the cooking applications.

### Examples of cooking applications

The information given in the following table is for guidance only.

Settings	Use for
0	Element off
1 - 3	Delicate warming
4 - 5	Gentle simmering, slow warming
6 - 7	Reheating and rapid simmering
8	Boiling, saute and searing
9	Maximum heat
P	Boost function

### Cleaning tips

- Do not use abrasive pads, corrosive cleaners, aerosol cleaners or sharp objects to clean the surfaces of the hob.
- To remove burnt food, soak it off with a damp cloth and washing-up liquid.
- You may use a scraper for cleaning food or residues. Sticky foods must be cleaned immediately when they spill, before the glass has cooled down.
- Be careful not to scratch the silicon adhesive placed on the edges of the glass whilst using a scraper.
- The scraper has a razor, therefore, it must be kept away from children.
- Use special ceramic hob cleaner on the hob while it is warm to touch. Rinse and wipe dry with a clean cloth or paper towel.

## INSTALLATION OF THE APPLIANCE

### WARNING:

The electrical connection of this hob should be carried out by a qualified electrician, according to the instructions in this guide and in compliance with the current regulations. In the event of any damage that occurs as a result of improper connection or installation, the warranty will not be valid. This appliance must be earthed.

### Installation safety

- Any overhanging surface should be at least 65cm above the hob.
- Extractor fans must be fitted in accordance with the manufacturer's instructions.
- The wall in contact with the rear of the hob must be made of flameproof material.
- The power cable length should not exceed 2 metres.

### Fitting the hob into a work surface

- The hob can be inserted into any worktop provided it is heat resistant up to at least 90°C.
- Create an opening with the dimensions shown in the picture below and on next page.
- Induction hob may be built in the 25 to 40 mm thick worktops.

### 78cm induction hob

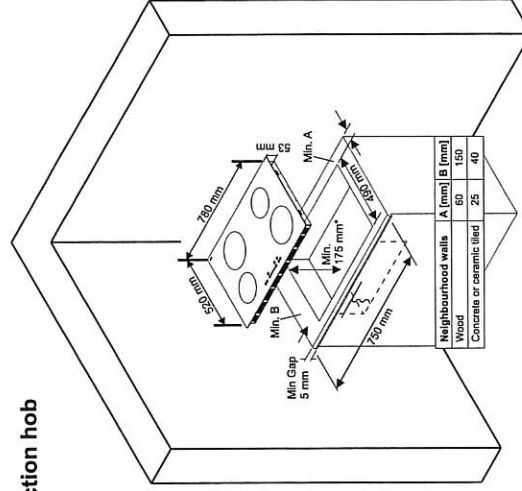

\*: In the case of installation over built in oven, distance should be min. 10 mm.



Screw the 4 worktop mounting brackets on the side walls of product.

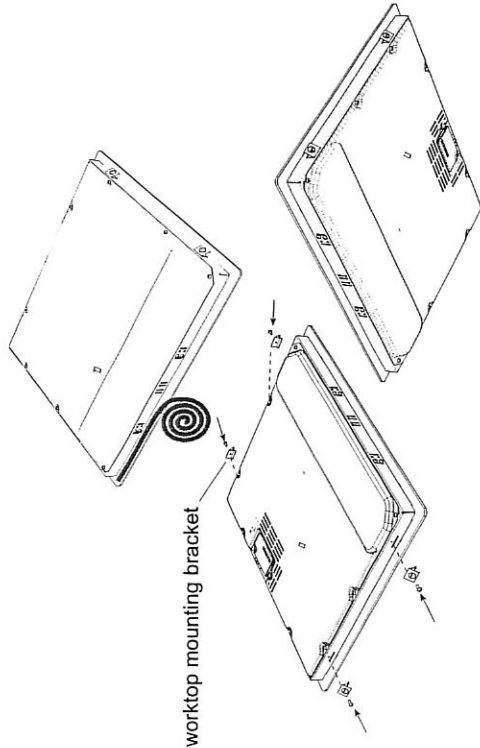

- Secure the hob in place by putting it into cutout on the work surface.
- Before inserting the oven, it is necessary to remove the rear kitchen element panel in the area of the oven opening, in order to supply cooling. Equally, the front part of the kitchen element must have an opening of no less than 5 mm.

### Making an electrical connection

Before making a connection, check that:

- The mains voltage is the same as that quoted on the rating plate which is situated at the back of your hob.
- The circuit can support the appliance load (see the rating plate).
- The power supply has an earth connection, which complies with the provisions of current regulations and is in good working order.
- The fused switch is easily accessible once the hob has been installed.

If there is no dedicated hob circuit and fused switch, they must be installed by a qualified electrician before the hob is connected.

An approved suitable cable must be connected from the Consumer Unit (main fuse box) and be protected by its own 32amp fuse or Micro Circuit Breaker (MCB). The electrician must provide a fused all pole switch, which disconnects both the line (live) and neutral conductors with a contact separation of at least 3.0 mm.

The fused switch should be fitted to the kitchen wall, above the worksurface and to the side of the hob, not above it, in accordance with IEE regulations. Connect the fused switch to a junction box which should be fitted on the wall about 61cm (24 inches) above floor level and behind the hob. The hob's power supply cable can then be connected. Connect one end to the junction box and connect the other end to the hob's power connection box which is located at the back of the hob. Remove the cover of the power connection box and install the cable, in accordance with the connection diagram.

The power supply cable must be positioned away from direct heat sources. It should not be subjected to a temperature rise of more than 50°C above room temperature.

This appliance conforms with the following EU Directives:

- 2006/95/EC Low Voltage Directive
- 2004/108/EC EMC Directive
- 93/68/EEC CE Marking Directive

**Electrical connection diagram**

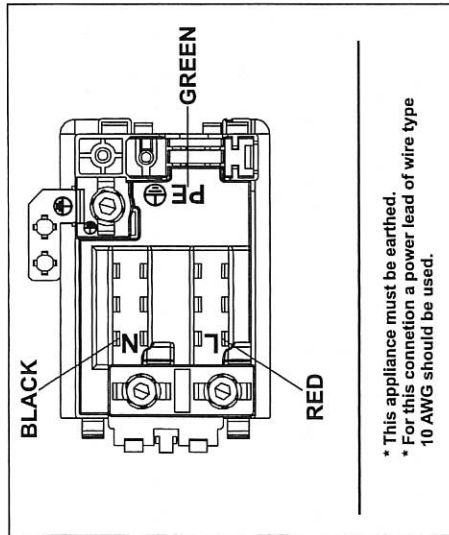





For the induction hob, the cable must be suitable for region will be used. You will find the connection diagram shown on the bottom of your appliance.

**ERROR CODES**

If there is an error, error code will be showed at heater displays.

**E1** : Cooling Fan is disabled, call authorized service agents.

**E3** : Supply voltage is over than rated values, turn the hob off by touching , wait until "H" disappears for all zones, turn the hob on by touching  and continue to use. If same error is seems again, call authorized service agents.

**E4**: Supply frequency is different from rated values, turn the hob off by touching , wait until "H" disappears for all zones, turn the hob on by touching  and continue to use. If same error is seems again, plug off/on turn the hob on by touching  continue to use it. If same error is still seem call authorized service agents.

**E5**: Hob inside temperature is too high, turn the hob off by touching  let heaters cool down.

**E6**: Communication error between touch control and heater, call authorized service agents.

**E7**: Coil temperature sensor is disabled, call authorized service agents.

**E8**: Cooler temperature sensor is disabled, call authorized service agents.

**E9**: Calibration error, call authorized service agents.