



TRUE RESIDENTIAL®

TR-30 / TR-36

INSTALLATION / USER GUIDE



PRESERVE THE MOMENT®



212530

THANK YOU

FOR YOUR PURCHASE

INDEX

OWNERSHIP, SAFETY PRECAUTIONS, DISPOSAL OF OLD REFRIGERATOR, CFC DISPOSAL

3-4

SITE PREPARATION, ELECTRICAL REQUIREMENTS, ANTI-SWEAT FOAM END PANELS

5-8

PLAN VIEWS

9-16

ANTI-TIP BRACKET INSTALLATION, LEVELING THE UNIT, JOINING KIT INSTALLATION

17-26

REFRIGERATOR AND FREEZER BASIC ELECTRONIC CONTROL OPERATIONS, SHOWROOM MODE

37-34

DUAL ZONE BASIC ELECTRONIC CONTROL OPERATIONS, SHOWROOM MODE

35-42

SHELVING, REFRIGERATOR STORAGE, FREEZER STORAGE, REMOVING THE DOORS,
KICK PLATE INSTALLATION

43-46

STAINLESS STEEL EQUIPMENT CARE & CLEANING, GENERAL MAINTENANCE, CONDENSATION,
DATA TAG, WARRANTY STATEMENT, CONTACT US

47-50

NOTE:

AS WE STRIVE FOR CONTINUOUS IMPROVEMENTS, FEATURES AND SPECIFICATIONS ARE SUBJECT TO CHANGE WITHOUT NOTICE.

30 & 36 INCH REFRIGERATOR, FREEZER & DUAL ZONE COLUMN

30" REFRIGERATOR
BEVERAGE COLUMN

STAINLESS GLASS DOOR

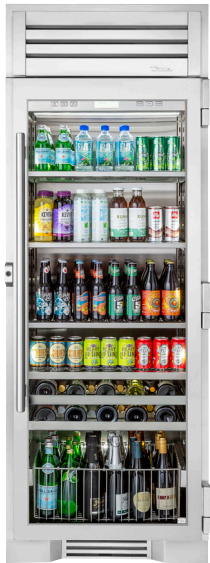

30" REFRIGERATOR
COLUMN

STAINLESS SOLID DOOR



30" REFRIGERATOR
COLUMN

STAINLESS GLASS DOOR



30" FREEZER
COLUMN

STAINLESS SOLID DOOR



30" DUAL ZONE
WINE COLUMN

STAINLESS GLASS DOOR



36" REFRIGERATOR
COLUMN

STAINLESS SOLID DOOR



36" REFRIGERATOR
COLUMN

STAINLESS GLASS DOOR



36" FREEZER
COLUMN

STAINLESS SOLID DOOR



*Commercial refrigeration refined for the home, envied in the industry,
and crafted—gorgeously—in America.*

OWNERSHIP

SAFETY PRECAUTIONS

DISPOSAL OF THE OLD REFRIGERATOR

CFC DISPOSAL



OWNERSHIP

THIS APPLIANCE IS NOT INTENDED FOR USE BY PERSONS (INCLUDING CHILDREN) WITH REDUCED PHYSICAL, SENSORY OR MENTAL CAPABILITIES, OR LACK OF EXPERIENCE AND KNOWLEDGE, UNLESS THEY HAVE BEEN GIVEN SUPERVISION OR INSTRUCTION CONCERNING USE OF THE APPLIANCE BY A PERSON RESPONSIBLE FOR THEIR SAFETY.

TO INSURE THAT YOUR UNIT WORKS PROPERLY FROM THE FIRST DAY, IT MUST BE INSTALLED PROPERLY.

NOTE: WE HIGHLY RECOMMEND A TRAINED REFRIGERATION MECHANIC AND ELECTRICIAN INSTALL YOUR TRUE RESIDENTIAL® CABINET. THE COST OF A PROFESSIONAL INSTALLATION IS MONEY WELL SPENT.

Before you start to install your True Residential® Cabinet, carefully inspect it for freight damage. If damage is discovered, immediately file a claim with the delivery freight carrier. True is not responsible for damage incurred during shipment. This appliance is intended to be used in household and similar applications such as:

- Staff kitchen areas in shops, offices and other working environments;
- Bed and breakfast type environments;
- Catering and similar non-retail applications.

Any questions about the installation please contact your True dealer or True Technical Service Department at 844-746-9423. Please have your model and serial numbers available when you call our Service Department.

SAFETY PRECAUTIONS

- This refrigerator must be properly installed and located in accordance with the installation instructions before it is used.
- Do not allow children to climb, stand or hang on the shelves in the refrigerator. They could seriously injure themselves or damage the refrigerator.

- Do not store or use gasoline or other flammable vapors and liquids in the vicinity of this or any other appliance.
- Keep hands away from the “pinch point” areas (gaps between the doors and between the doors and cabinet). Small areas are not necessarily safe.
- Unplug the refrigerator before cleaning and making repairs.
- Setting temperature control to OFF only removes power from the refrigeration system, it does not remove power from other circuits. For example, temperature control and lights.

NOTE: WE STRONGLY RECOMMEND THAT ANY SERVICING BE PERFORMED BY A QUALIFIED INDIVIDUAL.

PROPER DISPOSAL OF THE OLD REFRIGERATOR

DANGER: Risk of child entrapment. Before you throw away your old refrigerator or freezer:

- Take off the doors
- Leave the shelves in place so that children may not easily climb inside

DANGER: Risque de piégeage de l'enfant. Avant de jeter votre vieux réfrigérateur ou congélateur:

- Enlevez les portes.
- Laissez les étagères en place de sorte que les enfants ne puissent pas facilement monter à l'intérieur.



CFC DISPOSAL

Your old refrigerator may have a cooling system that used CFCs (chlorofluorocarbons). CFCs are believed to harm stratospheric ozone. If you are throwing away your old refrigerator, make sure the CFC refrigerant is removed for proper disposal by a qualified service. If you intentionally release this CFC refrigerant you can be subject to fines and imprisonment under provisions of the environment legislation.

SITE PREPARATION

ELECTRICAL REQUIREMENTS

ANTI-SWEAT FOAM END PANELS



SITE PREPARATION

- Rough Opening dimensions. (See figure 1)
- For FLUSH installations the front face of the unit will be flush with the surrounding cabinets. (See figure 2)
- For PROUD (Standard) installations, the front face of the unit will extend beyond cabinets. (See figure 3)

NOTE: IT IS NOT RECOMMENDED TO INSTALL UNITS SIDE BY SIDE WITH HINGES TOUCHING EACH OTHER. IF YOU PLAN TO INSTALL UNITS HINGE TO HINGE, CALL TECH SUPPORT AT 844-746-9423 FOR INSTALLATION INSTRUCTIONS.

TR-30

FLUSH OPENING DIMENSIONS

Width	Depth	Height
30 1/4"	25 25/32"	84 1/4"

PROUD OPENING DIMENSIONS

Width	Depth	Height
29 3/4"	23 25/32"	84"

TR-36

FLUSH OPENING DIMENSIONS

Width	Depth	Height
36 1/4"	25 25/32"	84 1/4"

PROUD OPENING DIMENSIONS

Width	Depth	Height
35 3/4"	23 25/32"	84"

* BECAUSE OF THE WEIGHT OF THIS UNIT, IT IS RECOMMENDED TO CONSULT A FLOORING EXPERT PRIOR TO INSTALLATION. THE FLOORING BENEATH THE UNIT SHOULD BE RATED TO SUPPORT AT LEAST 150 POUNDS PER SQUARE FOOT.

**TR-30 – FRONT VIEW
FIGURE 1 - ROUGH OPENING
& ELECTRICAL AREA**

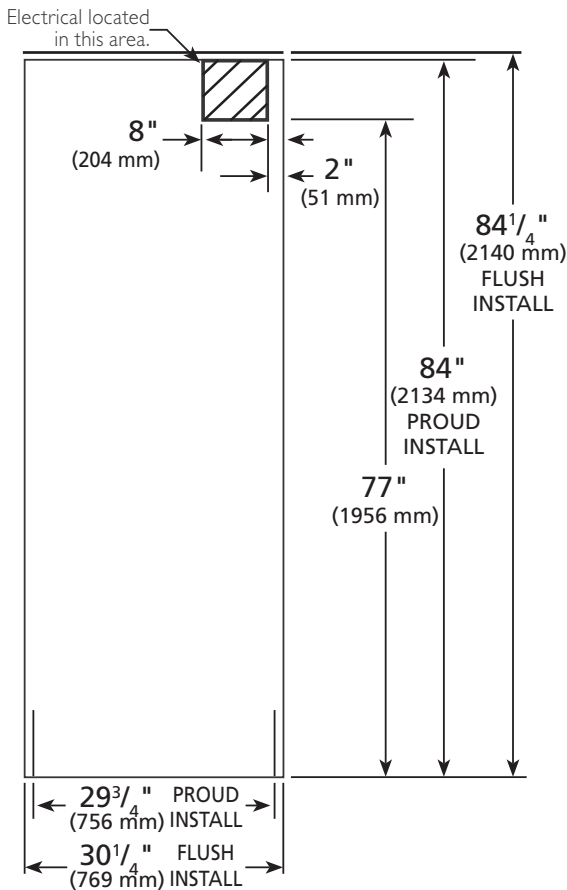

**TR-30 – TOP VIEW
FIGURE 2 - FLUSH INSTALL**

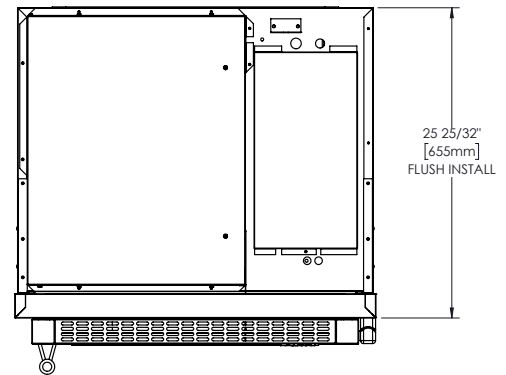

**TR-30 – TOP VIEW
FIGURE 3 - PROUD INSTALL**

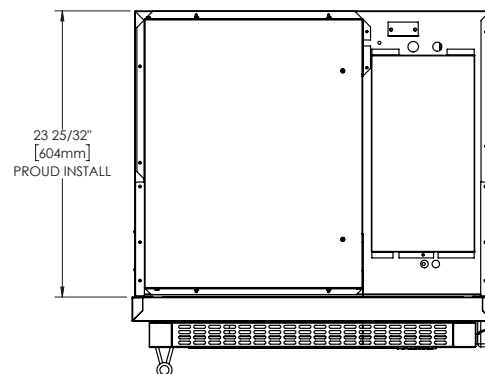

NOTE: DIMENSIONS MAY VARY BY ± 1/8"

TR-30 – TOP VIEW

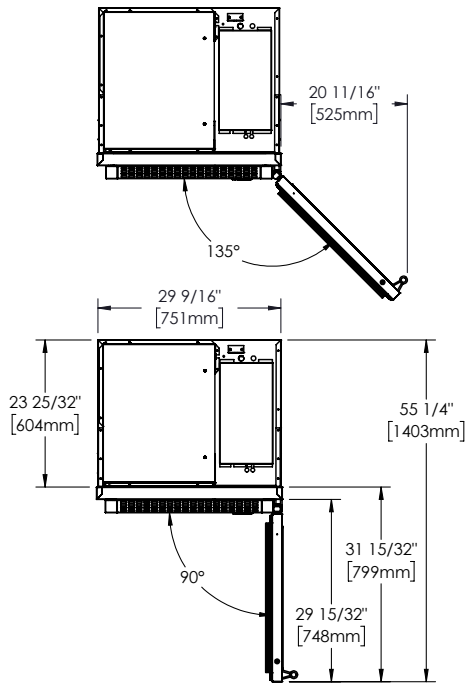

TR-30 – FRONT VIEW

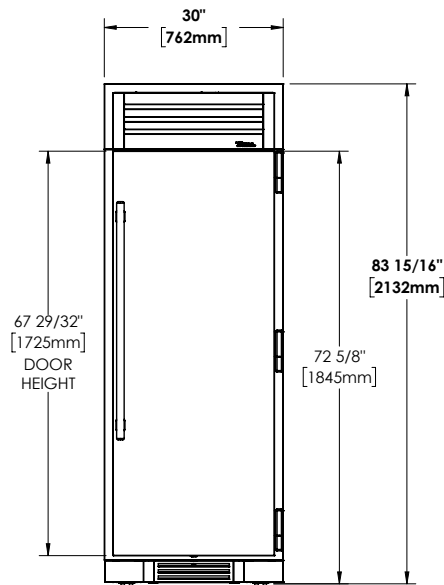

TR-30 – SIDE VIEW

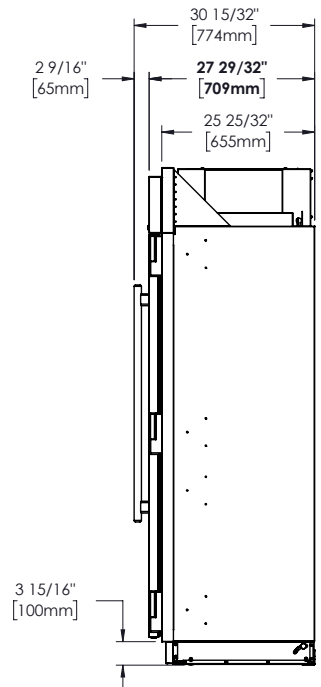

TR-36 – TOP VIEW

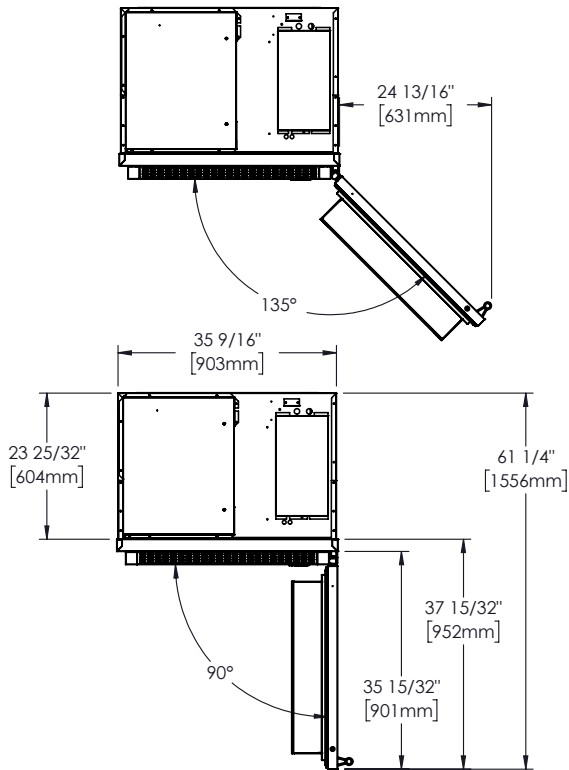

TR-36 – FRONT VIEW

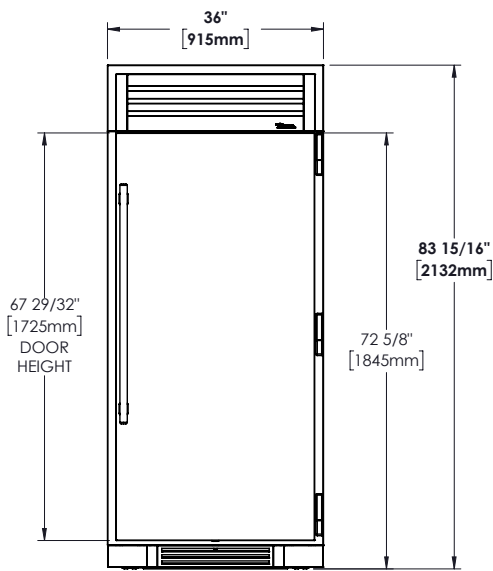

TR-36 – SIDE VIEW

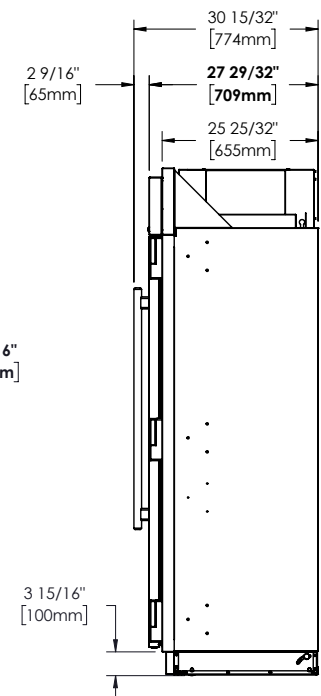

NOTE: DIMENSIONS MAY VARY BY ± 1/8"

ELECTRICAL REQUIREMENTS TR-30/TR-36

For all built-in models, the electrical supply should be located within the shaded area shown in the illustration. Follow the National Electrical Code and local codes and ordinances when installing the receptacle. A dedicated circuit, supplying only this appliance is required. A ground fault circuit interrupter (GFCI) is not recommended and may cause interruption of operation.

If the supply cord is damaged, it must be replaced by the manufacturer, its service agent or similarly qualified person in order to avoid a hazard.

- **POWER SUPPLY 115 V AC, 60 HZ**
- **CIRCUIT BREAKER 15 AMP**
- **RECEPTACLE 3-PRONG GROUNDING-TYPE**

NOTES:

- **THE OUTLET MUST BE CHECKED BY A QUALIFIED ELECTRICIAN TO BE SURE THAT IT IS WIRED WITH THE CORRECT POLARITY.**
- **VERIFY THAT THE OUTLET IS PROPERLY GROUNDED.**

TR-30/TR-36 – FRONT VIEW ROUGH OPENING & ELECTRICAL AREA

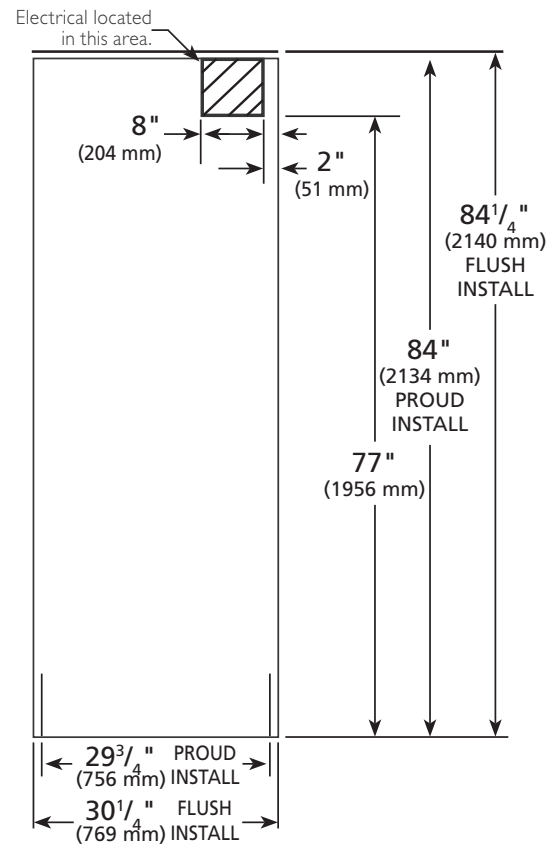

ANTI-SWEAT FOAM END PANELS

When installing two units side-by-side, it is recommended to leave a 5/8" gap between the cabinets, to ensure that moisture does not develop. Anti-sweat foam end panels can be purchased from our parts department by calling (844) 849-6226, or emailing trueresidentialparts@truemfg.com. If installing anti-sweat foam end panels, we recommend that a panel be applied to each of the units being joined together.

PLAN VIEWS

TR-30 / TR-42

TR-30 / TR-48

TR-30 / TR-30

TR-30 / TR-30 / TR-30

TR-36 / TR-36

TR-36 / TR-30



TR-30 / TR-42

FLUSH OPENING DIMENSIONS

Width	Depth	Height
72 1/4"	25 25/32"	84 1/4"

PROUD OPENING DIMENSIONS

Width	Depth	Height
71 3/4"	23 25/32"	84"

NOTE: DIMENSIONS MAY VARY BY ± 1/8"

FLUSH VS. PROUD INSTALL

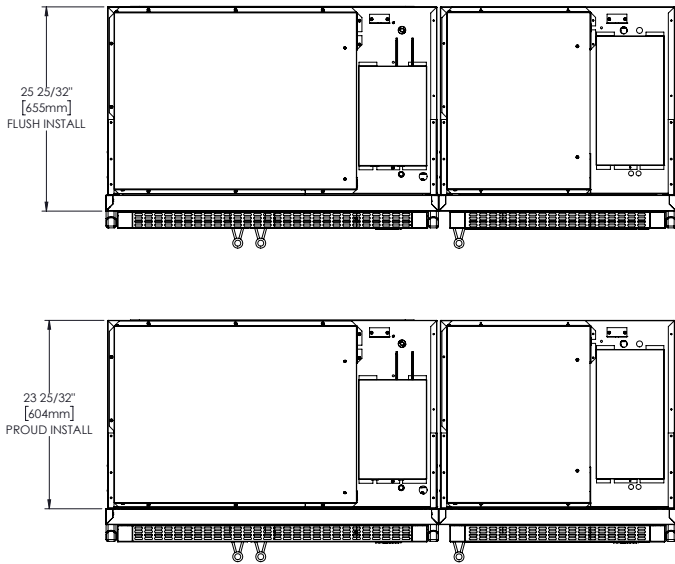

ROUGH OPENING & ELECTRICAL AREA

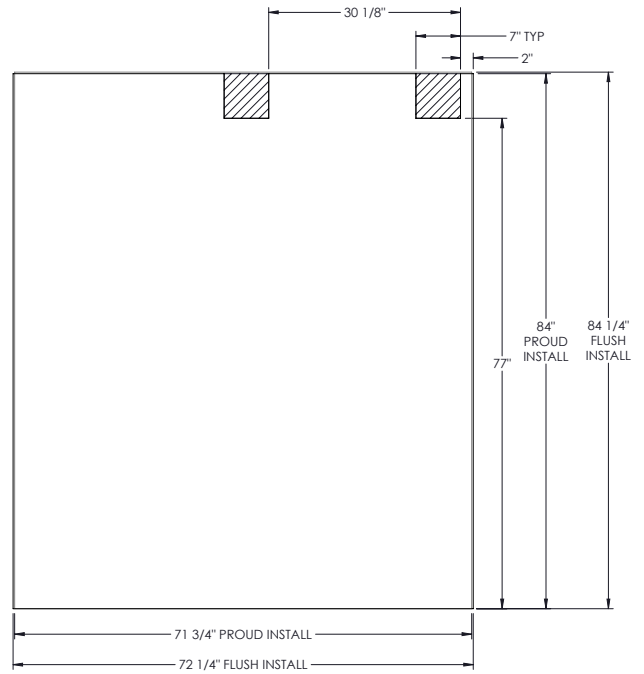

PLAN VIEW

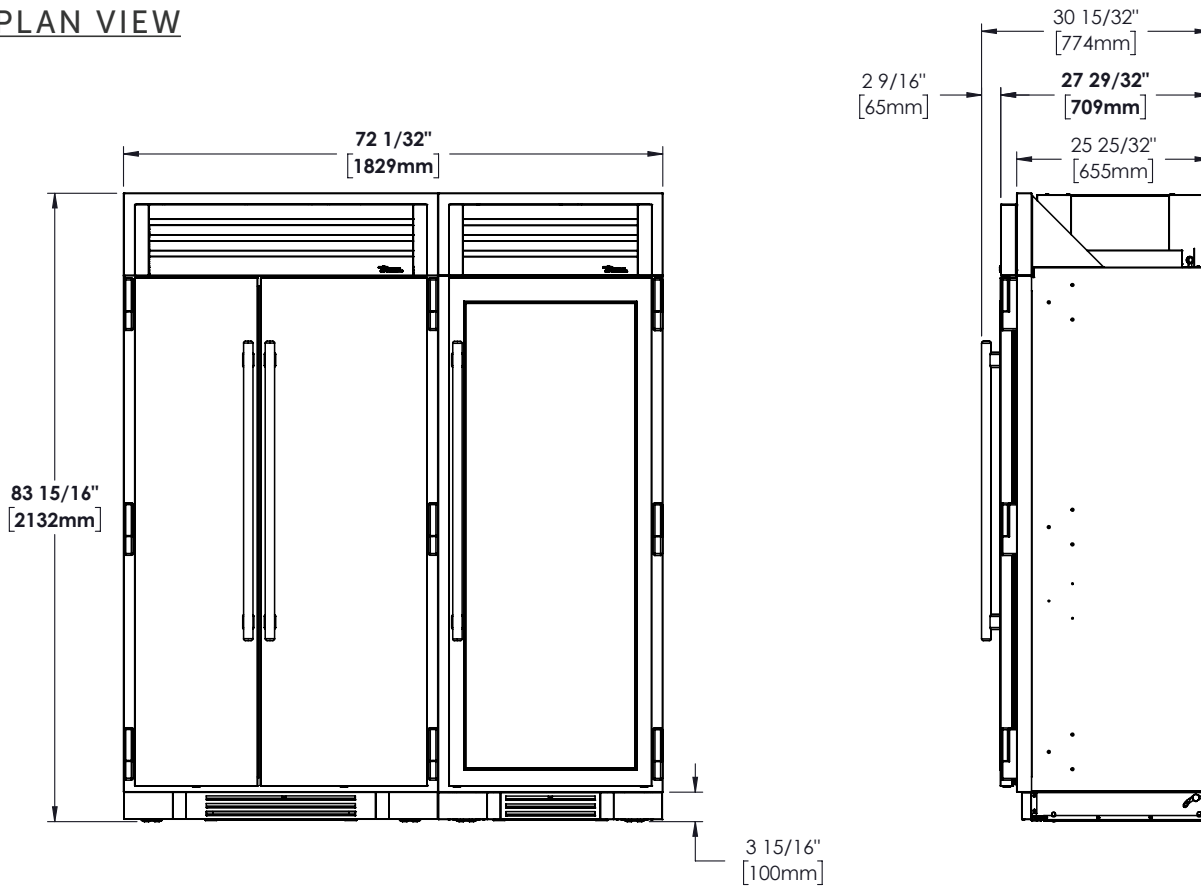

TR-30 / TR-48

FLUSH OPENING DIMENSIONS

Width	Depth	Height
78 1/4"	25 25/32"	84 1/4"

PROUD OPENING DIMENSIONS

Width	Depth	Height
77 3/4"	23 25/32"	84"

NOTE: DIMENSIONS MAY VARY BY ± 1/8"

FLUSH VS. PROUD INSTALL

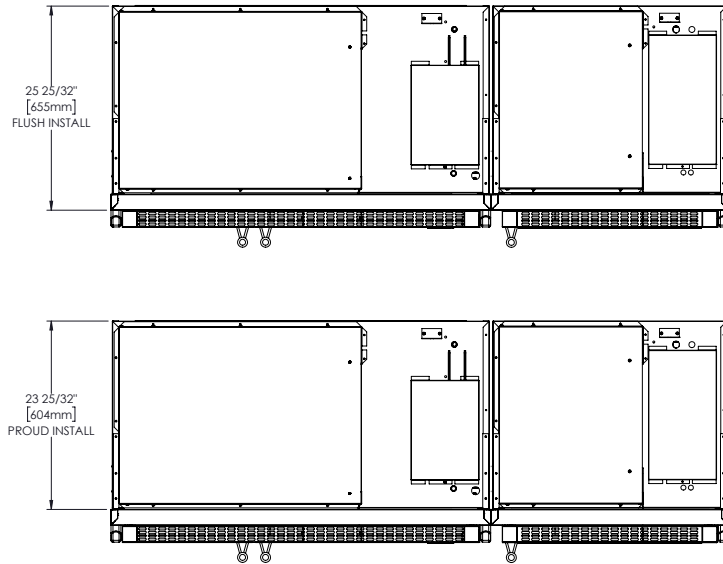

ROUGH OPENING & ELECTRICAL AREA

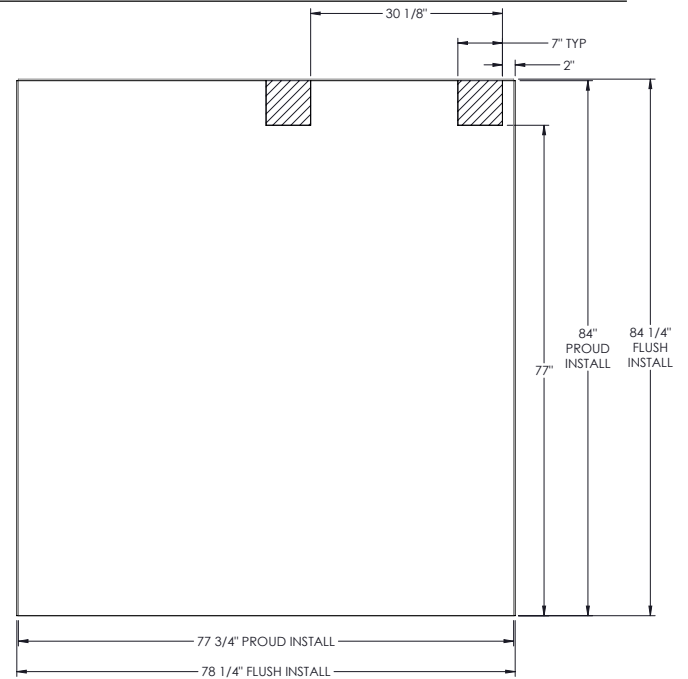

PLAN VIEW

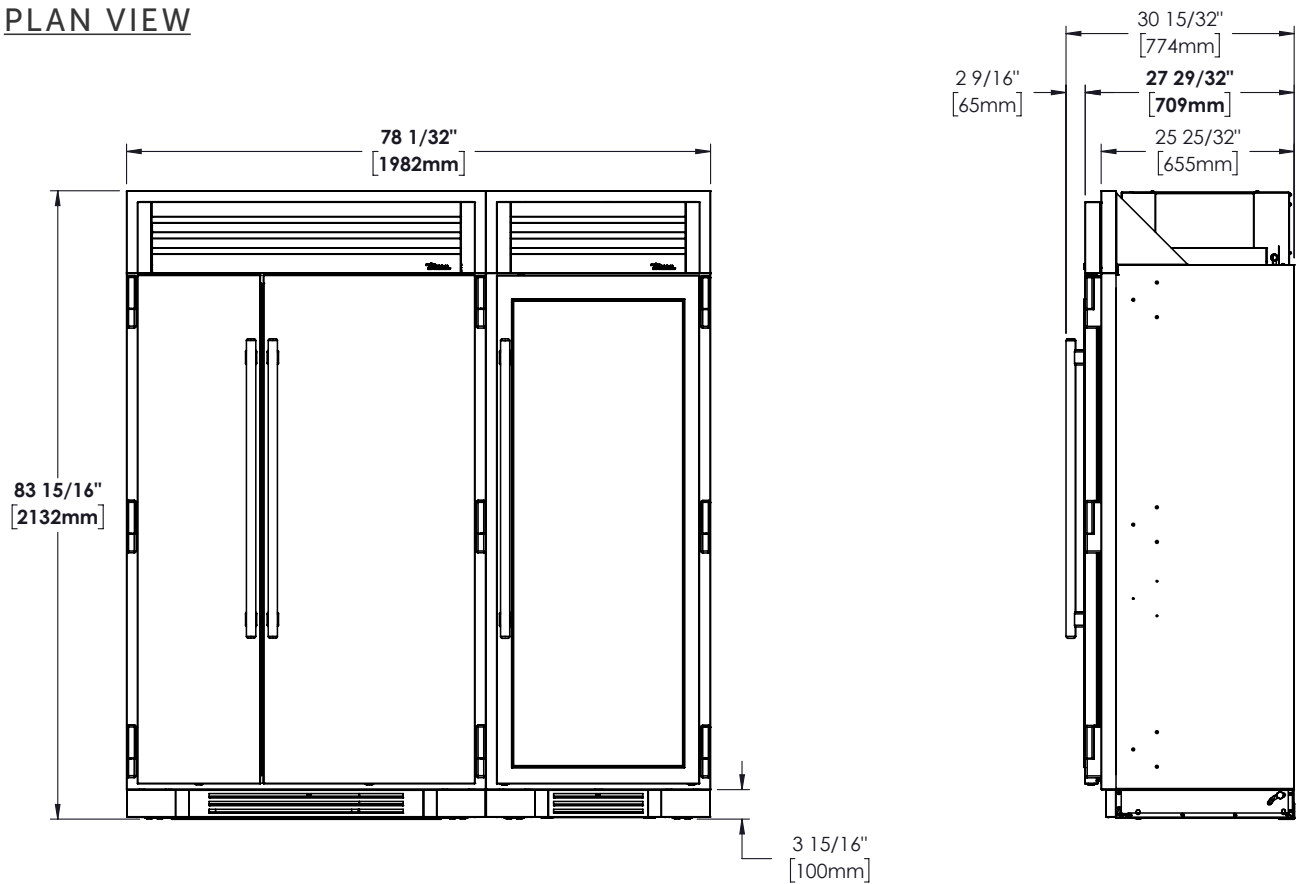

TR-30 / TR-30

FLUSH OPENING DIMENSIONS

Width	Depth	Height
60 1/4"	25 29/32"	84 1/4"

PROUD OPENING DIMENSIONS

Width	Depth	Height
59 3/4"	23 25/32"	84"

NOTE: DIMENSIONS MAY VARY BY ± 1/8"

FLUSH VS. PROUD INSTALL

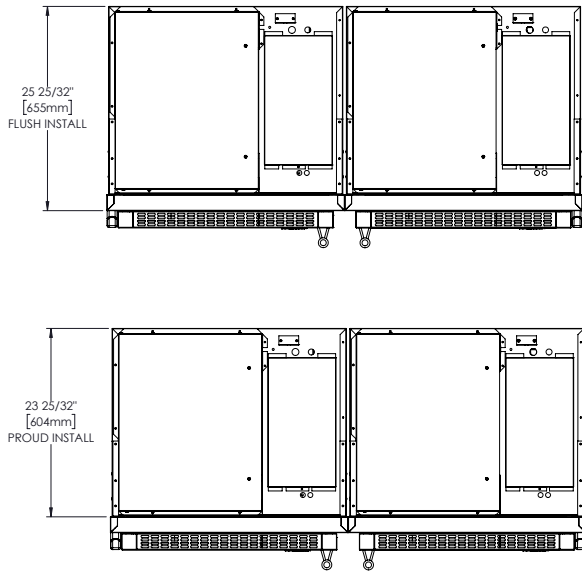

ROUGH OPENING & ELECTRICAL AREA

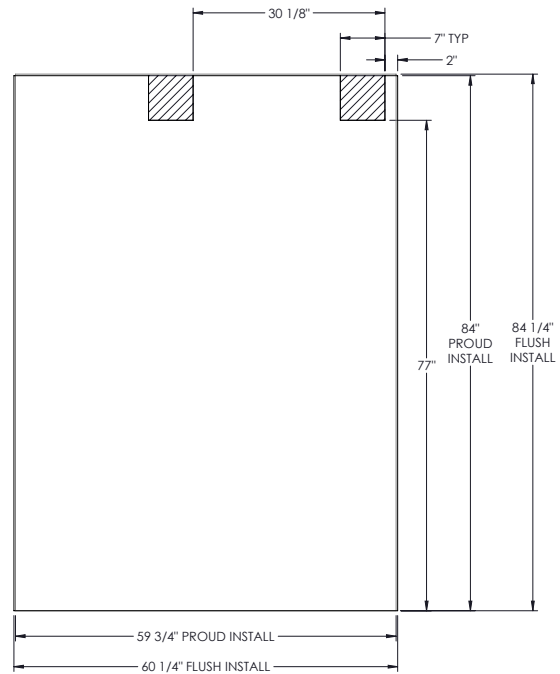

PLAN VIEW

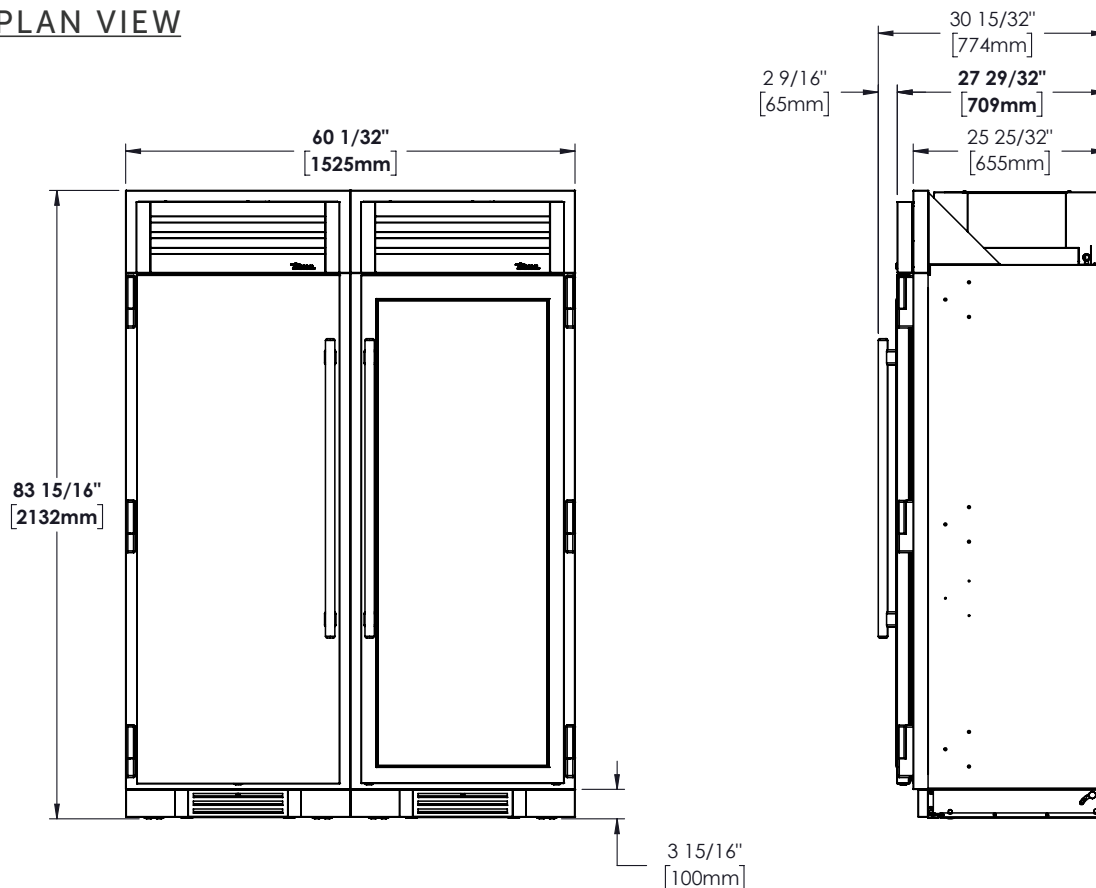

TR-30 / TR-30 / TR-30

FLUSH OPENING DIMENSIONS

Width	Depth	Height
90 1/4"	25 25/32"	84 1/4"

PROUD OPENING DIMENSIONS

Width	Depth	Height
89 3/4"	23 25/32"	84"

FLUSH VS. PROUD INSTALL

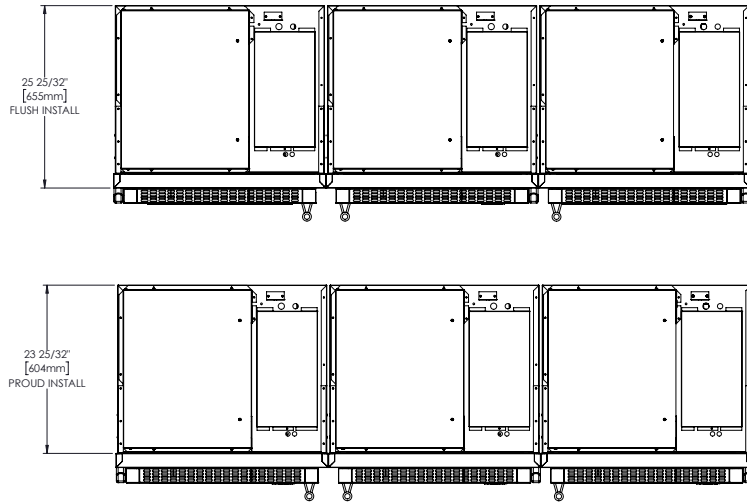

ROUGH OPENING & ELECTRICAL AREA

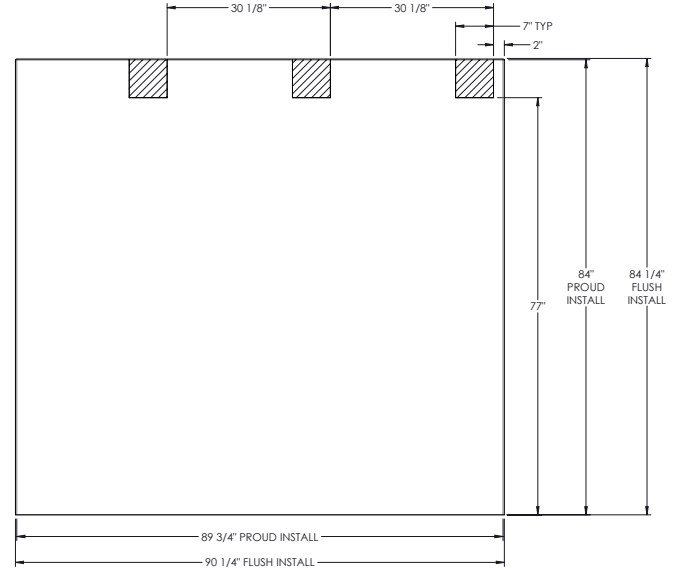

PLAN VIEW

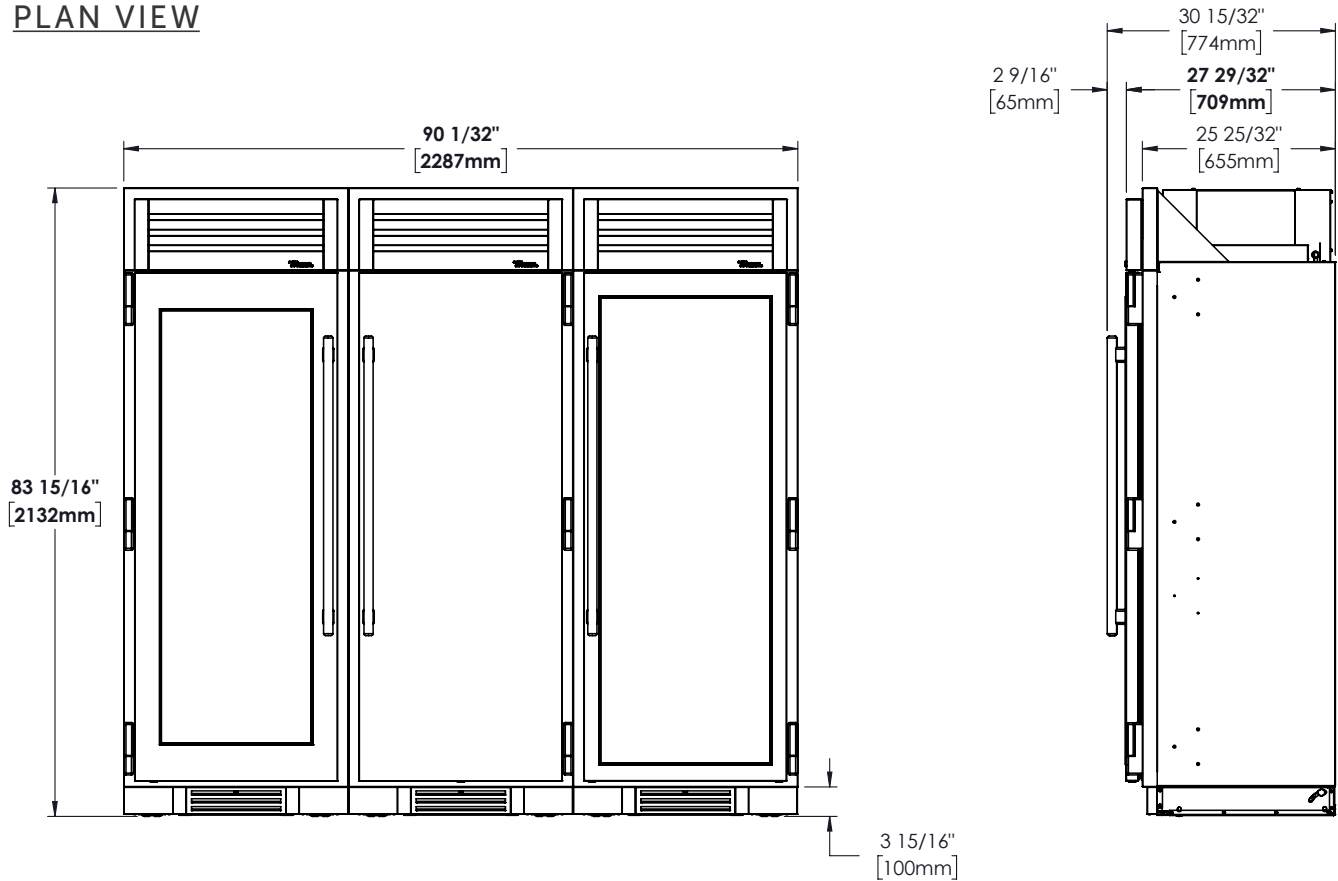

TR-36REF / TR-36REF

FLUSH OPENING DIMENSIONS

Width	Depth	Height
72 1/4"	25 25/32"	84 1/4"

PROUD OPENING DIMENSIONS

Width	Depth	Height
71 3/4"	23 25/32"	84"

NOTE: DIMENSIONS MAY VARY BY ± 1/8"

FLUSH VS. PROUD INSTALL

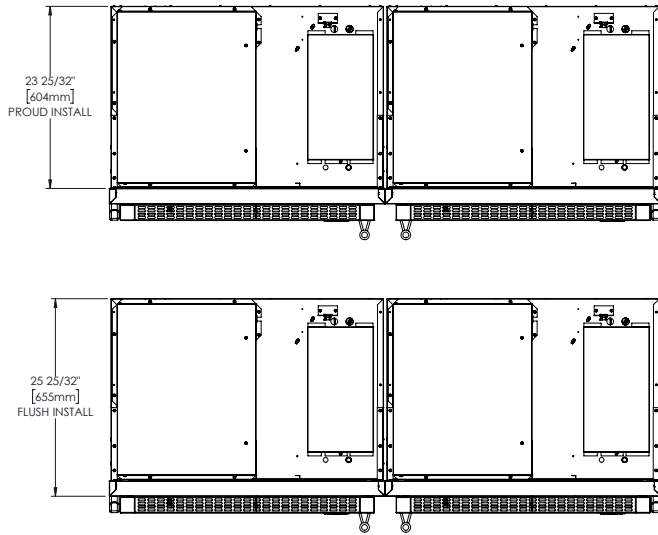

ROUGH OPENING & ELECTRICAL AREA

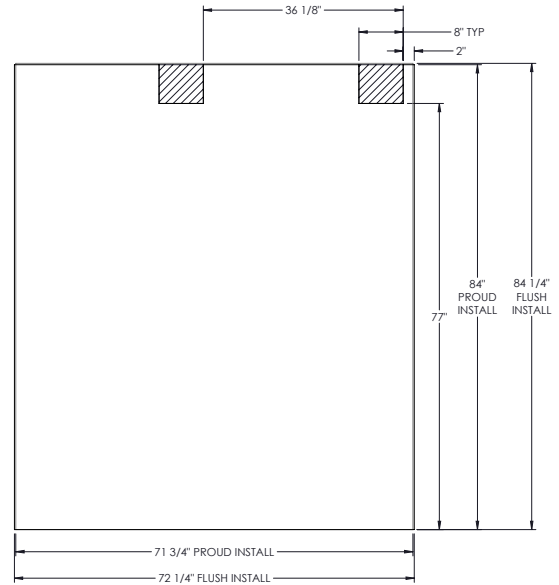

PLAN VIEW

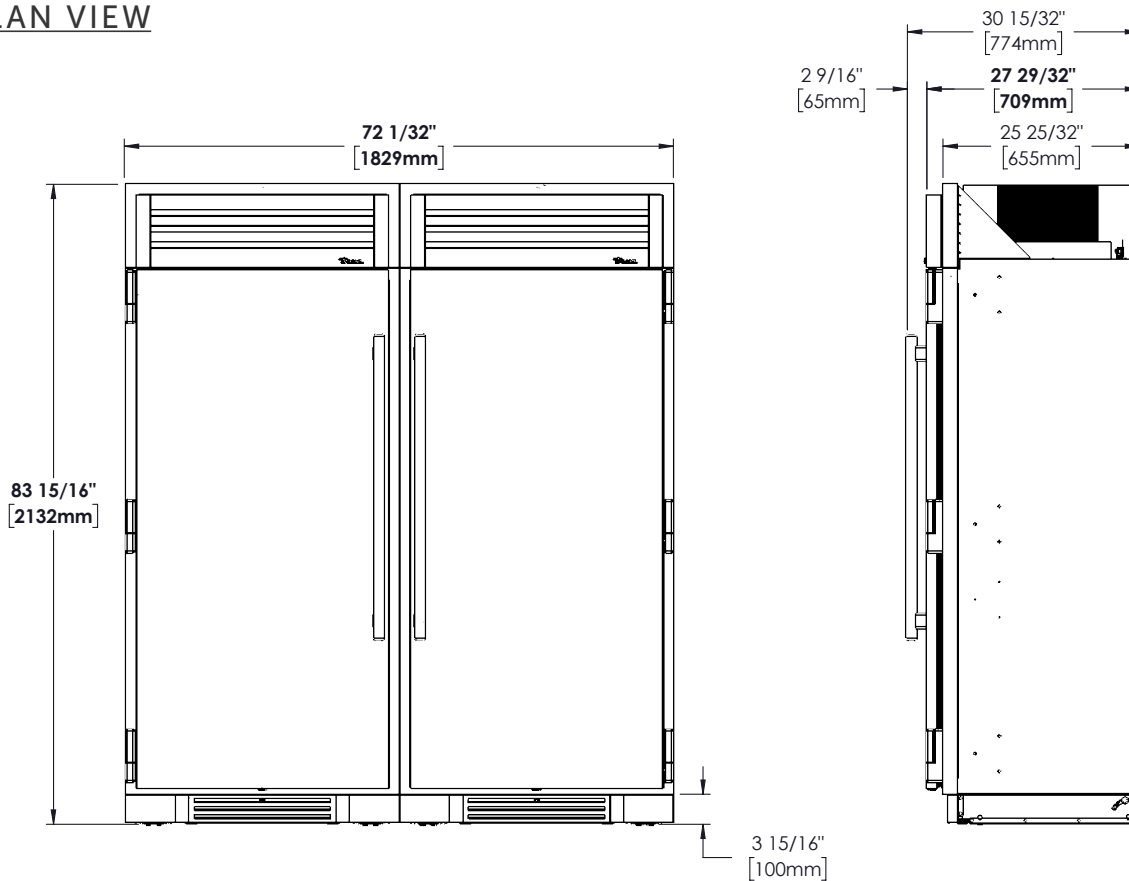

TR-36REF / TR-30REF

FLUSH OPENING DIMENSIONS

Width	Depth	Height
66 1/4"	25 25/32"	84 1/4"

PROUD OPENING DIMENSIONS

Width	Depth	Height
65 3/4"	23 25/32"	84"

NOTE: DIMENSIONS MAY VARY BY ± 1/8"

FLUSH VS. PROUD INSTALL

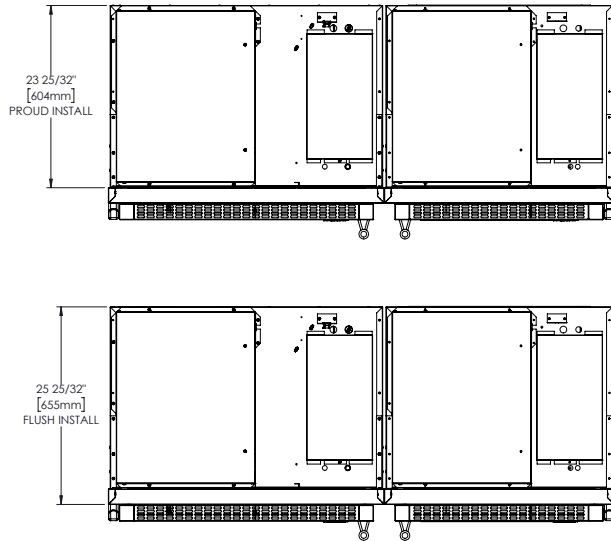

ROUGH OPENING & ELECTRICAL AREA

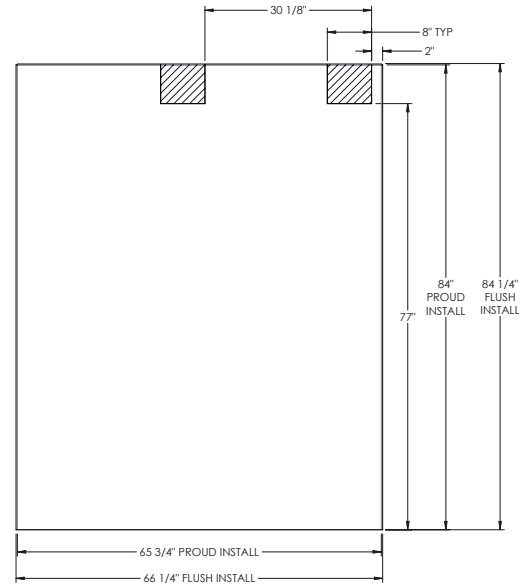

PLAN VIEW

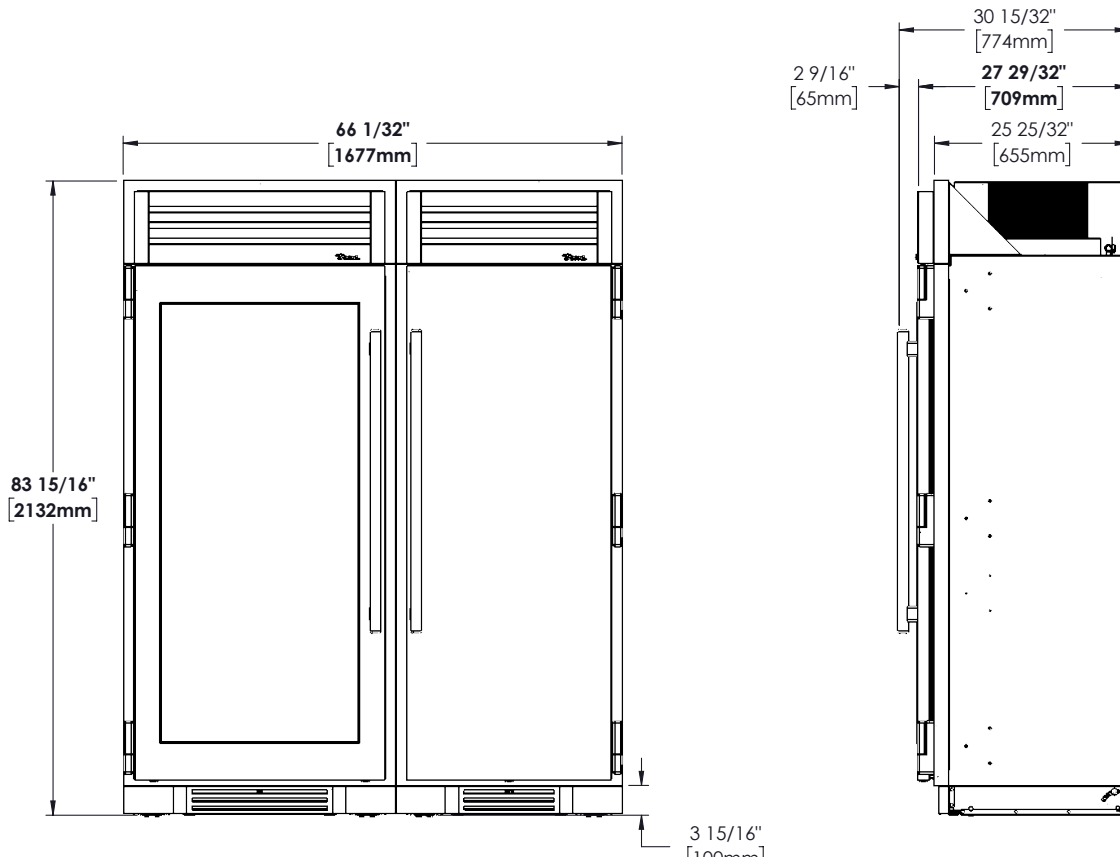

ANTI-TIP BRACKET INSTALLATION

LEVELING THE UNIT

JOINING KIT INSTALLATION



UPRIGHT ANTI-TIP BRACKET INSTALLATION



KIT INCLUDES

- One (1) anti-tip bracket
- Four (4) 3/16" masonry screws
- Eight (8) #12 -2" wood screws
- Twelve (12) 1/4" washers

TOOLS REQUIRED

- Tape measure
- Marking utensil
- 1/8" drill bit
- 7/16" socket
- Phillips bit driver
- Drill or ratchet



WARNING: To avoid a hazard from appliance instability, install the anti-tip bracket in accordance with the instructions below.

BEFORE YOU BEGIN

Consult a flooring expert to confirm that the flooring where the unit will be installed is rated for at least 150 pounds per square foot.

STEP 1

Measure and mark the depth of the bracket's placement in the installation location.

- For a flush installation: 24 31/32"
- For a proud installation: 22 31/32"

STEP 2

Place and center the bracket at the measured depth.

STEP 3

With the bracket as a guide, drill pilot holes into the wall and/or floor.

NOTE: FOR INCREASED STABILITY, SECURE THE BRACKET TO AS MANY JOISTS AND/OR STUDS AS POSSIBLE.

STEP 4

With the provided hardware, secure the anti-tip bracket.

STEP 5

Adjust the rear leveling rollers 1/4 turn clockwise.

STEP 6

Slide the unit into place and hook the anti-tip bracket into the castor assembly slots.

30 INCH / 36 INCH UNIT

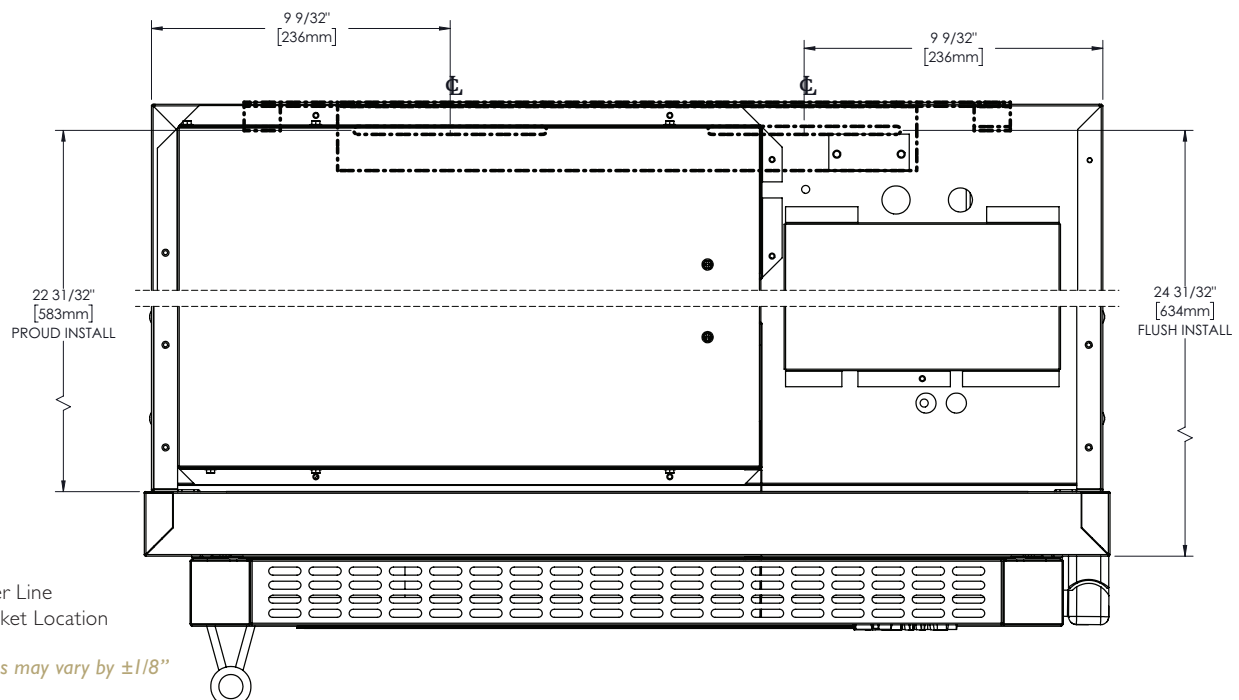

42 INCH UNIT

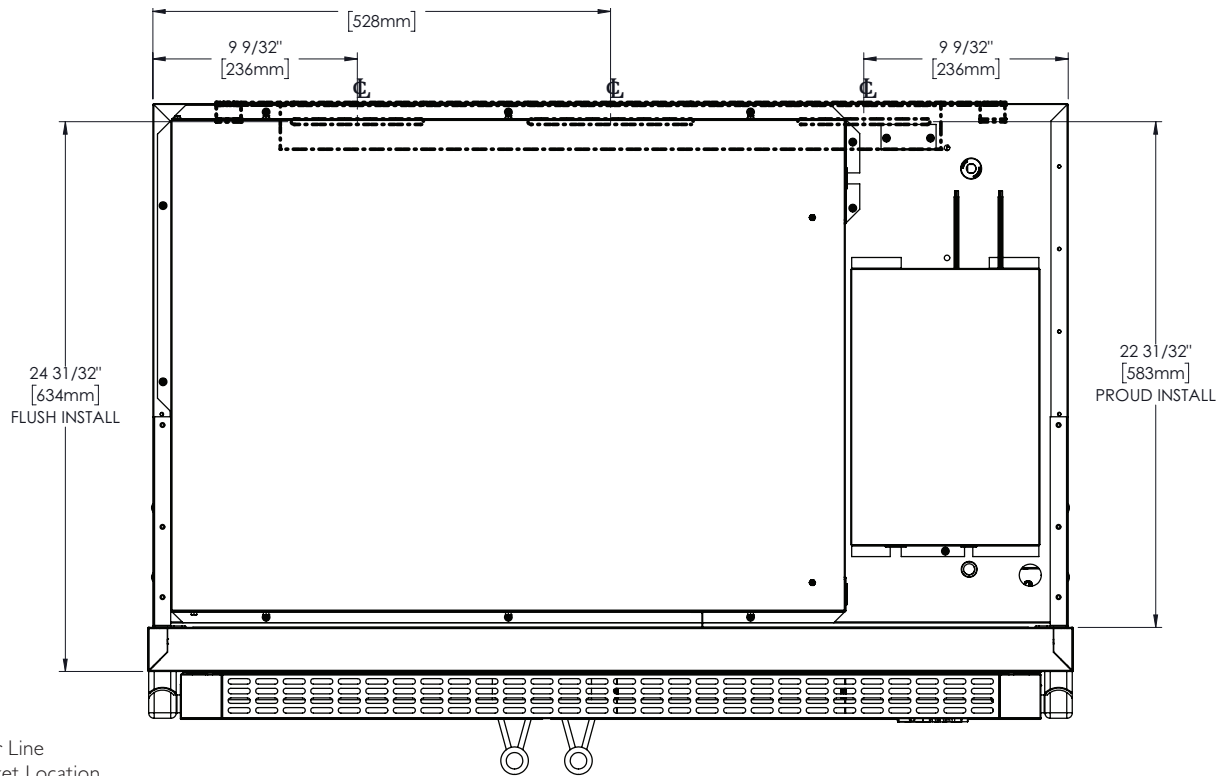

*Dimensions may vary by $\pm 1/8$ "

48 INCH UNIT

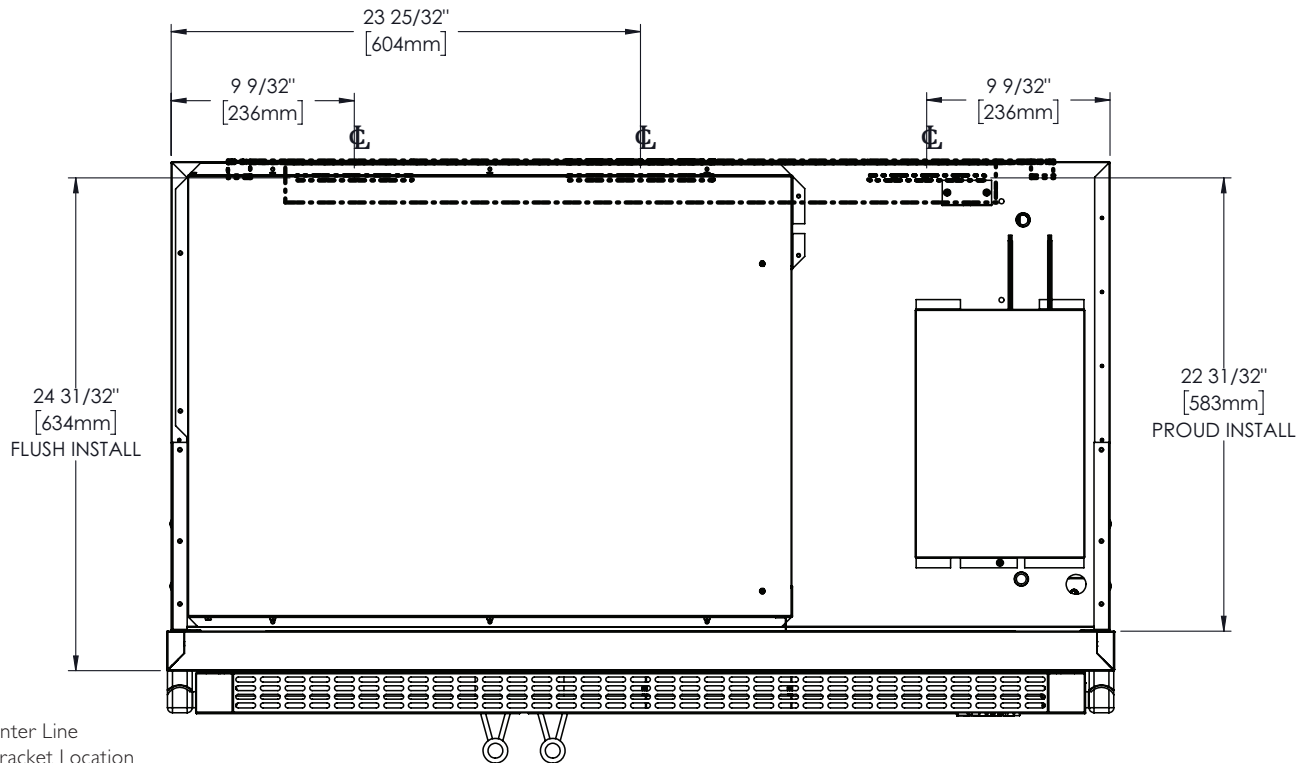

*Dimensions may vary by $\pm 1/8$ "

LEVELING THE UNIT

It is very important that the refrigerator sits level. This will insure that the doors will align and seal properly and that the drain pans will not spill over.

TO LEVEL THE UNIT:

STEP 1. Place a level on the interior floor. Check and adjust so the unit is level from front to back, and left to right.

STEP 2. Adjust the front legs using a set of pliers or a wrench.

STEP 3. Adjust the rear using a 7/16" socket and ratchet. Turn clockwise to raise the rear of the unit.

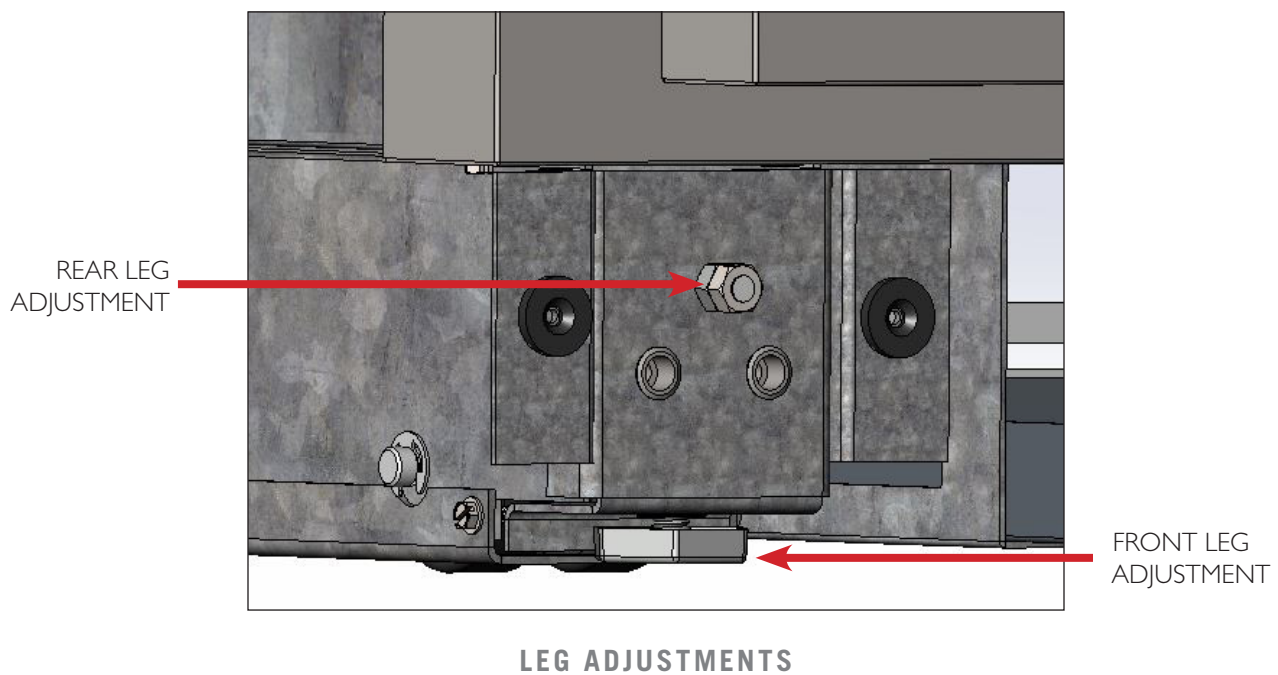

TR-30 60"/90" JOINING KIT INSTALLATION

KIT INCLUDES

- A. 60" Grill or 90" Grill
- B. Anti-sweat foam end panels
- C. Pop rivets
- D. Lower joining bracket
- E. Joining bracket bolts
- F. Joining bracket lock washers

TOOLS REQUIRED

- Phillips screwdriver
- Power drill
- 3/32" drill bit
- 7/16" socket
- 1/4" socket
- Pop rivet gun

NOTE: MAKE SURE THE ANTI-TIP BRACKETS ARE INSTALLED PER INSTALLATION MANUAL INSTRUCTIONS. EACH UNIT WILL ALSO NEED TO BE PROPERLY LEVELED PER INSTALLATION MANUAL INSTRUCTIONS.

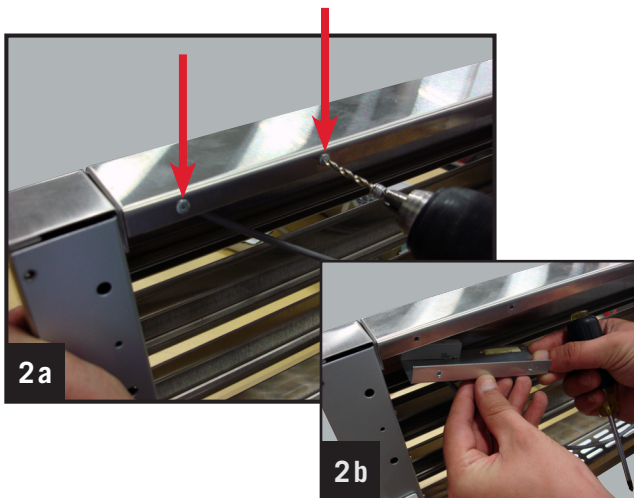

STEP 1

Unplug the cabinet(s).

STEP 2

Drill out the two pop rivets from the rain shield and remove reed switch bracket.

Make note of the bracket orientation, and mount the same way when reinstalling. When installed properly, you should see the back side of the metal bracket, and not the reed switch.

Images 2a & 2b.

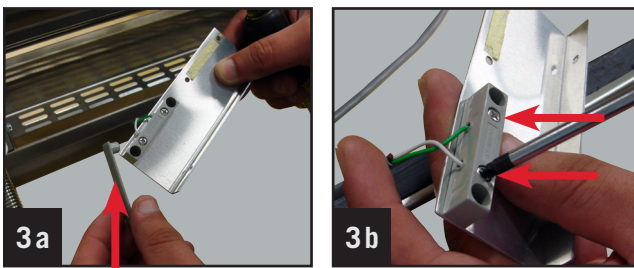

Plastic Cover

STEP 3

Remove the plastic cover on the reed switch to expose the two Phillips screws. Unscrew the Phillips screws to disconnect the wires from the reed switch.

Images 3a & 3b.

NOTE: SET BRACKET CONTAINING REED SWITCH ASIDE FOR REINSTALLATION ON NEW GRILL.



STEP 4

Remove the P-clip by unscrewing the 1/4" Phillips screw and remove the wire from the P-clip.

Image 4.

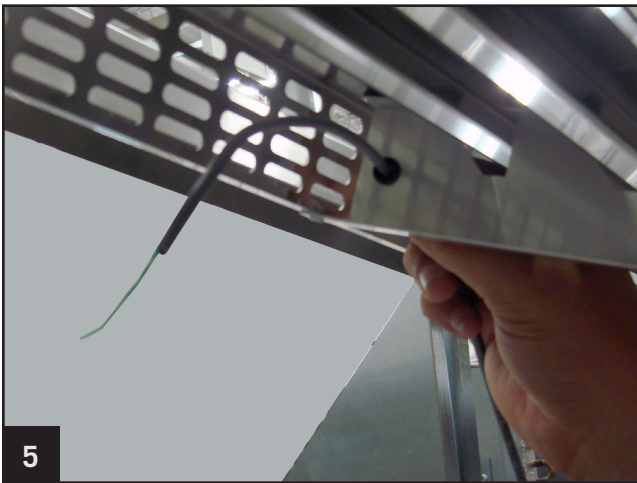

STEP 5

Pull reed switch wire through rain shield bushing and set the wires aside for later use.

Image 5.



STEP 6: REMOVE RAIN SHIELD FROM CABINETS

Unscrew two Phillips screws facing down and two on upper left and right side top of rain shield. Remove the rain shield from the unit.

Image 6.

NOTE: ALL HARDWARE YOU REMOVE WILL BE USED TO INSTALL THE NEW RAIN SHIELD.

NOTE: REPEAT STEPS 1-7 FOR EACH TR-30 UNIT YOU ARE INSTALLING.

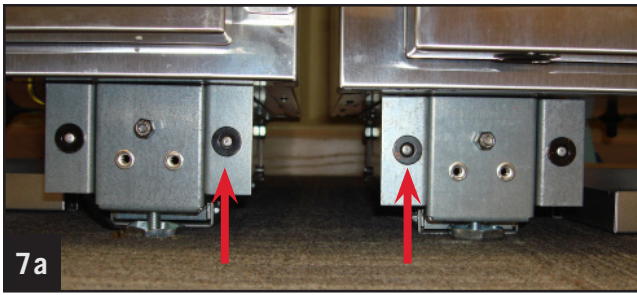

STEP 7

Remove the two 1/4" screws that hold the magnet bracket for the louver grill on the left right side of the units that are joining together. Remove both screws and set the bracket aside. This bracket will NOT reinstall with this application.

NOTE: REINSTALL THE SCREWS THAT WERE HOLDING THE BRACKET. THESE ARE USED TO SUPPORT THE CASTOR ASSEMBLY HOUSING.

Images 7a & 7b.

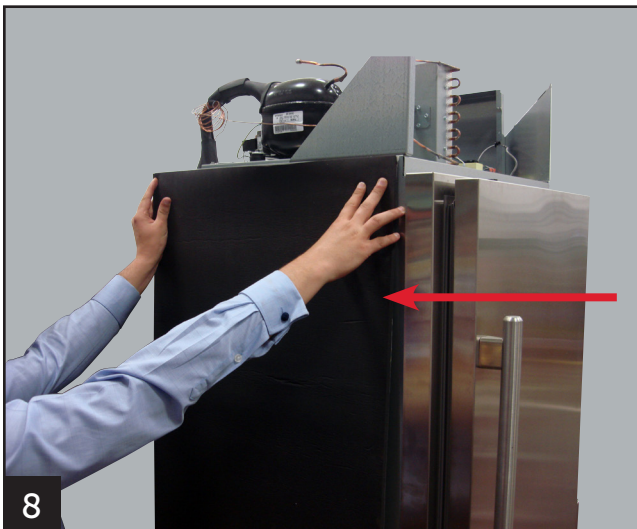
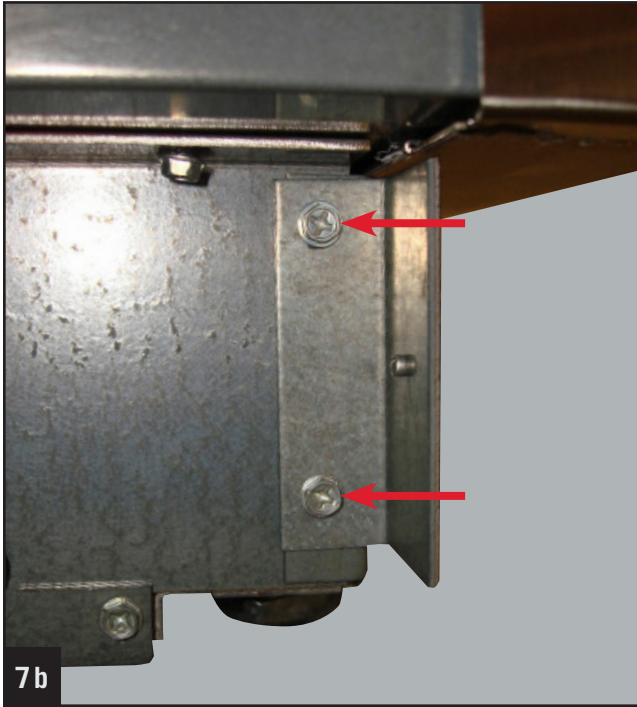

STEP 8

Install anti-sweat foam end panels on sides of units which will be joined together.

Image 8.

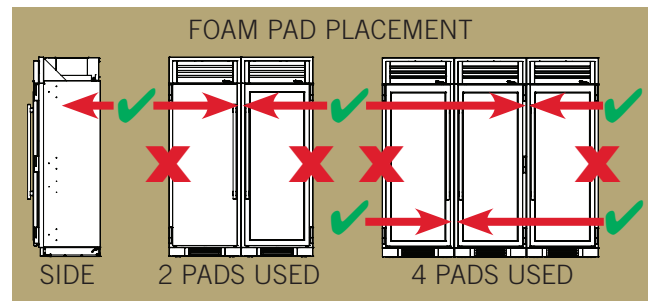

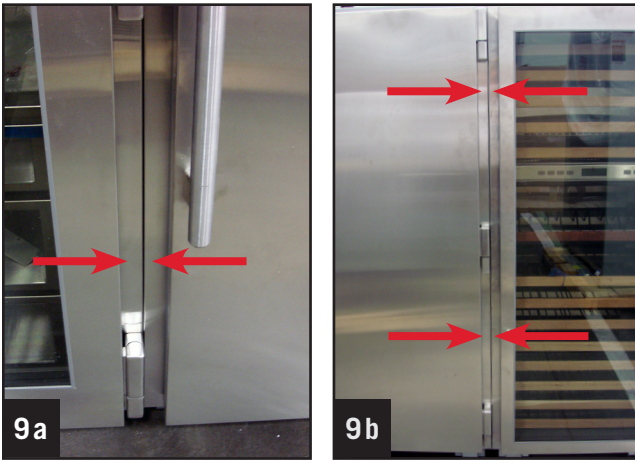

STEP 9

Place units in front of opening where they will be installed. Push units together and level the units to make sure the flanges where the two units meet are flush and the gap is consistent from top to bottom.

Image 9a & 9b.

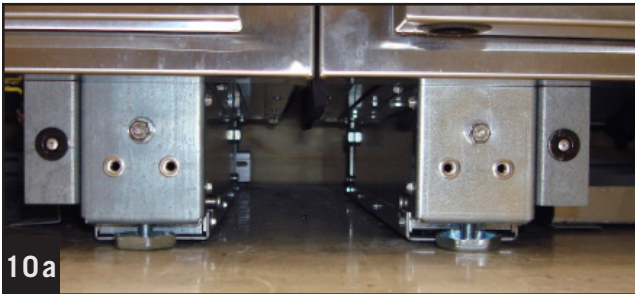

STEP 10

Once the units are pushed together and level, install the bottom joining kit bracket with the four 7/16" bolts and lock washers.

Image 10a & 10b.

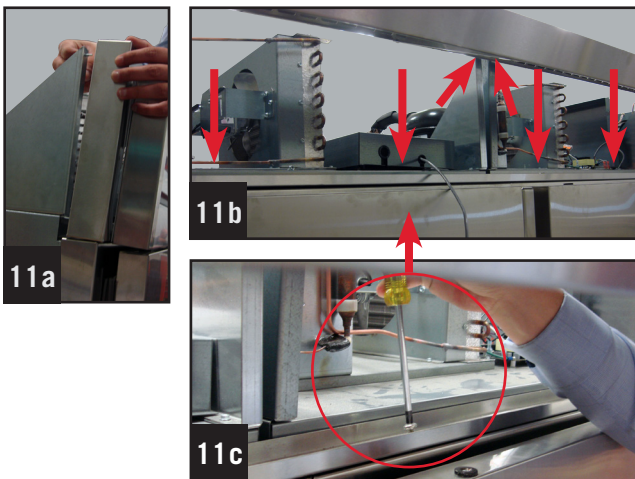

STEP 11: INSTALL NEW RAIN SHIELD

Install the 60 inch / 90 inch rain shield using the hardware previously removed.

Image 11a, 11b & 11c.

NOTE: IT'S RECOMMENDED TWO OR MORE PEOPLE ASSIST SETTING THE RAIN SHIELD IN PLACE WHILE IT'S BEING SECURELY MOUNTED.

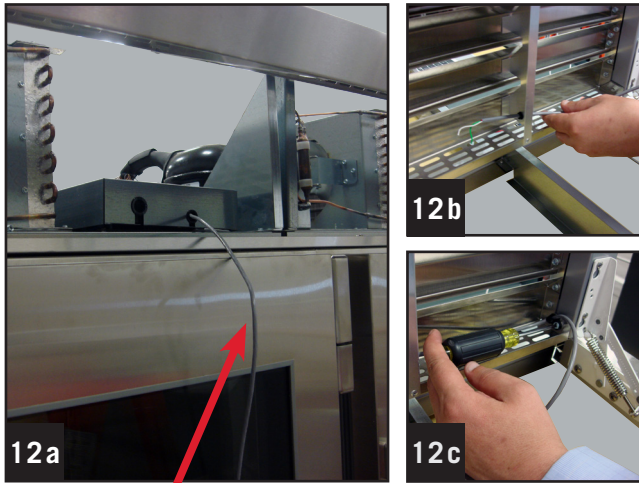

Reed Switch Wire

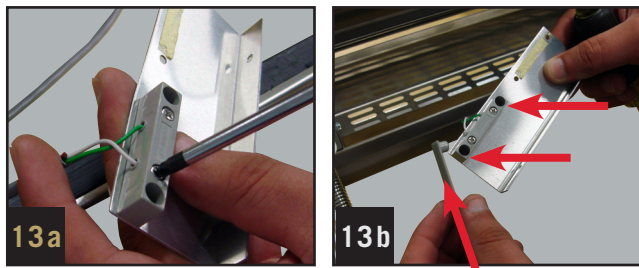

Pre-drilled Holes in Louver Grill

Plastic Cover



Magnet

STEP 12

Route the reed switch wires through the P-clips and bushings in the new grill.

Image 12a, 12b & 12c.

NOTE: P-CLIPS WILL ONLY BE USED ON EACH END OF THE NEW GRILL NOT IN THE CENTER (APPLIES TO 90 INCH ONLY).

STEP 13

Reconnect door switch wires to reed switch (it doesn't matter which wire goes to each terminal) and install the cover.

Image 13a & 13b.

STEP 14

Connect the reed switch to the new grill using the pre drilled holes and pop rivets. Pay close attention to how the doors are hinged, for this will determine where to install the door switch bracket into the louver grill. Each door has a magnet on the handle side of the door. The reed switch bracket will install in close proximity to this magnet.

Image 14.

STEP 15

Install the units into place by walking them into the opening. Make final leveling adjustments if needed. Close the louver grill, plug each unit in and turn the power on by holding the power button for 3 seconds.

STEP 16

Three minutes after plugging in the units, open and close each door individually, making sure the evaporator fans and lights are shutting off when the door is opened and closed. Note: all units have the ability to leave the lights on all the time, bypassing the door switch. However, the evaporator (interior) fans should always turn on and off with door openings. You should also hear a low-pitched click from the control board area when the door is opened and shut.

REFRIGERATOR AND FREEZER

BASIC ELECTRONIC OPERATIONS

SHOWROOM MODE



BASIC ELECTRONIC CONTROL OPERATIONS

UNIT ON/OFF

All units are shipped in ON Mode. When electricity is supplied to the appliance, a short power up diagnostics test is initiated followed by one audible beep, the lights energizing and temperature readings appearing in the LCD.

HOME SCREEN ON / OFF

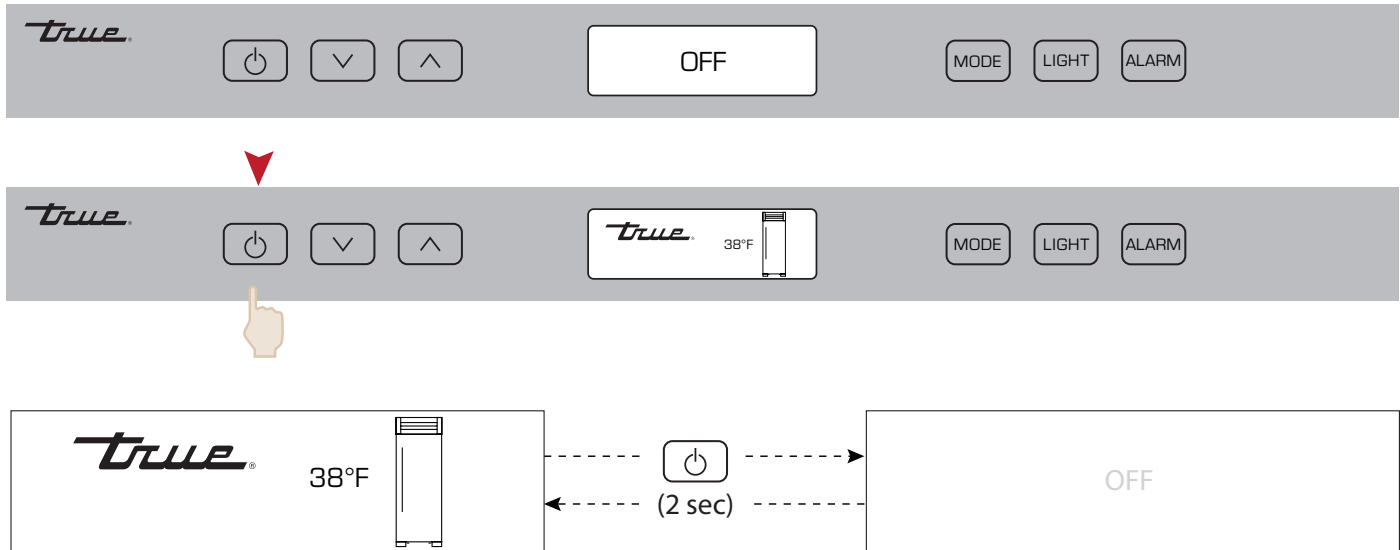

PLEASE NOTE THAT THOUGH POSSIBLE TO DISPLAY TEMPERATURES IN FAHRENHEIT OR CELSIUS, IN MOST CASES FAHRENHEIT READINGS ARE SHOWN IN THIS MANUAL.

TEMPERATURE ADJUSTMENT

To adjust set-point, press DOWN or UP key on control panel in multiple key strokes until the desired set-point is achieved. Each key stroke equals a one degree change and is accompanied by an audible beep. When the desired set-point is reached wait 5 seconds until display resumes "HOME" screen.

NOTES:

- THE TEMPERATURE RANGE IN A FREEZER ZONE IS -4°F (-20°C) TO +4°F (-16°C).
- THE TEMPERATURE RANGE IN A REFRIGERATOR ZONE IS +34°F (+1°C) TO +42°F (+6°C).
- INITIAL FACTORY SET-POINTS ARE 0°F (-18°C) IN A FREEZER ZONE AND 38°F (3°C) IN A REFRIGERATOR ZONE.
- THE INITIAL STROKE OF THE UP OR DOWN KEY WILL CHANGE THE PREVIOUS SET-POINT BY ONE DEGREE.

SET POINT NAVIGATION

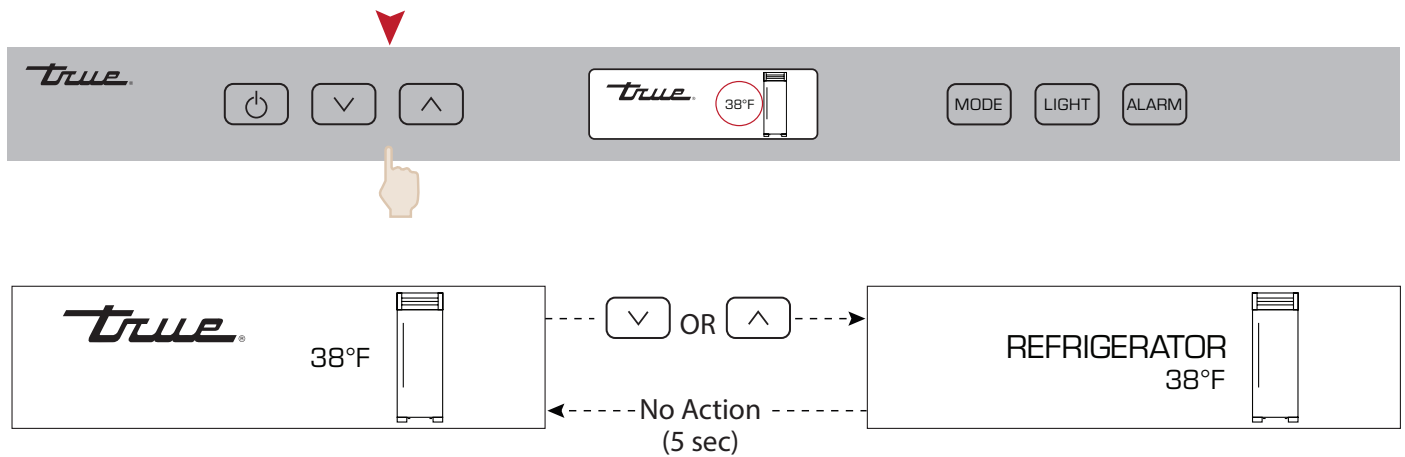

REFRIGERATOR 38°F / FREEZER 0°F

MODE NAVIGATION

The following pages illustrate unique customer input operations performed at the control panel. The input operations described are: **HOLIDAY MODE, TEMPERATURE UNIT SELECTION MODE AND VACATION MODE.**

NOTES: (HOLIDAY MODE)

- **SET-POINTS CANNOT BE CHANGED AND MANUAL DEFROST CANNOT BE INITIATED.**
- **THE FOLLOWING HOLDS TRUE IN ACCORDANCE WITH STAR-K REQUIREMENTS:**
 - Freezer defrosting functions will convert to a fixed time base sequence.
 - The compartment/zone thermistors will still detect cut-in and cut-out, which is the determining factor to start/stop the cooling process, but there will be a random sixteen (16) to twenty-one (21) second delay before cooling begins/ends.
 - The phrase “HOLIDAY MODE ACTIVE” in the LCD remains energized when the door is closed.

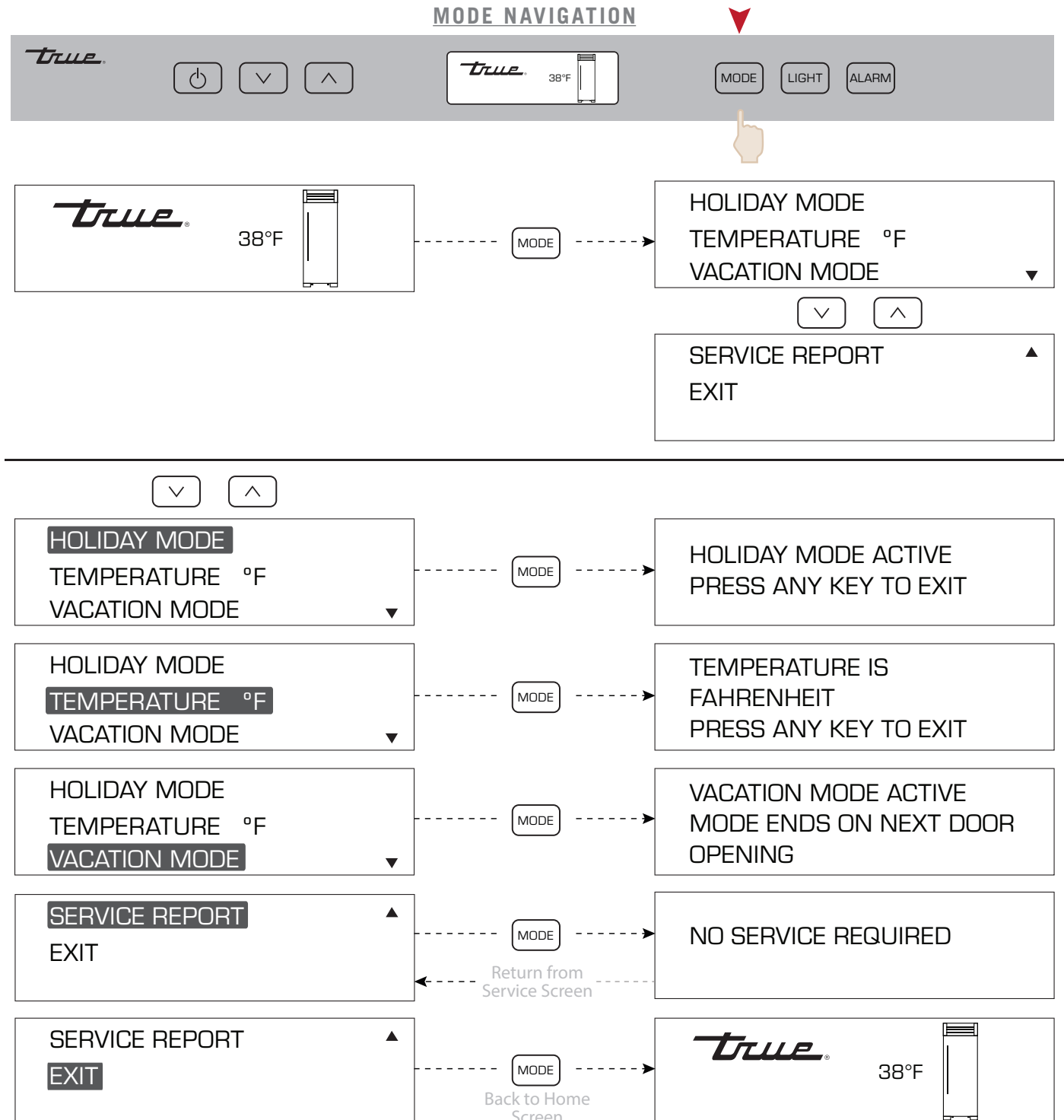

ACCENT LIGHTING SYSTEM

All models are equipped with an accent lighting system in the refrigerator and or freezer compartment(s). To energize the accent lighting system, press the LIGHT key, and navigate to the corresponding compartment, DOOR or ON will appear in the LCD indicating the accent lights are enabled. With the accent lighting system ON, the LED's will be energized and stay illuminated when the door is closed, in the DOOR position the lighting system will only be energized with the door opening.

NOTE:

- WHEN LIGHTS ARE PLACED IN "ON" MODE, LIGHTS WILL NOT FADE-UP WHEN DOOR OPENS.

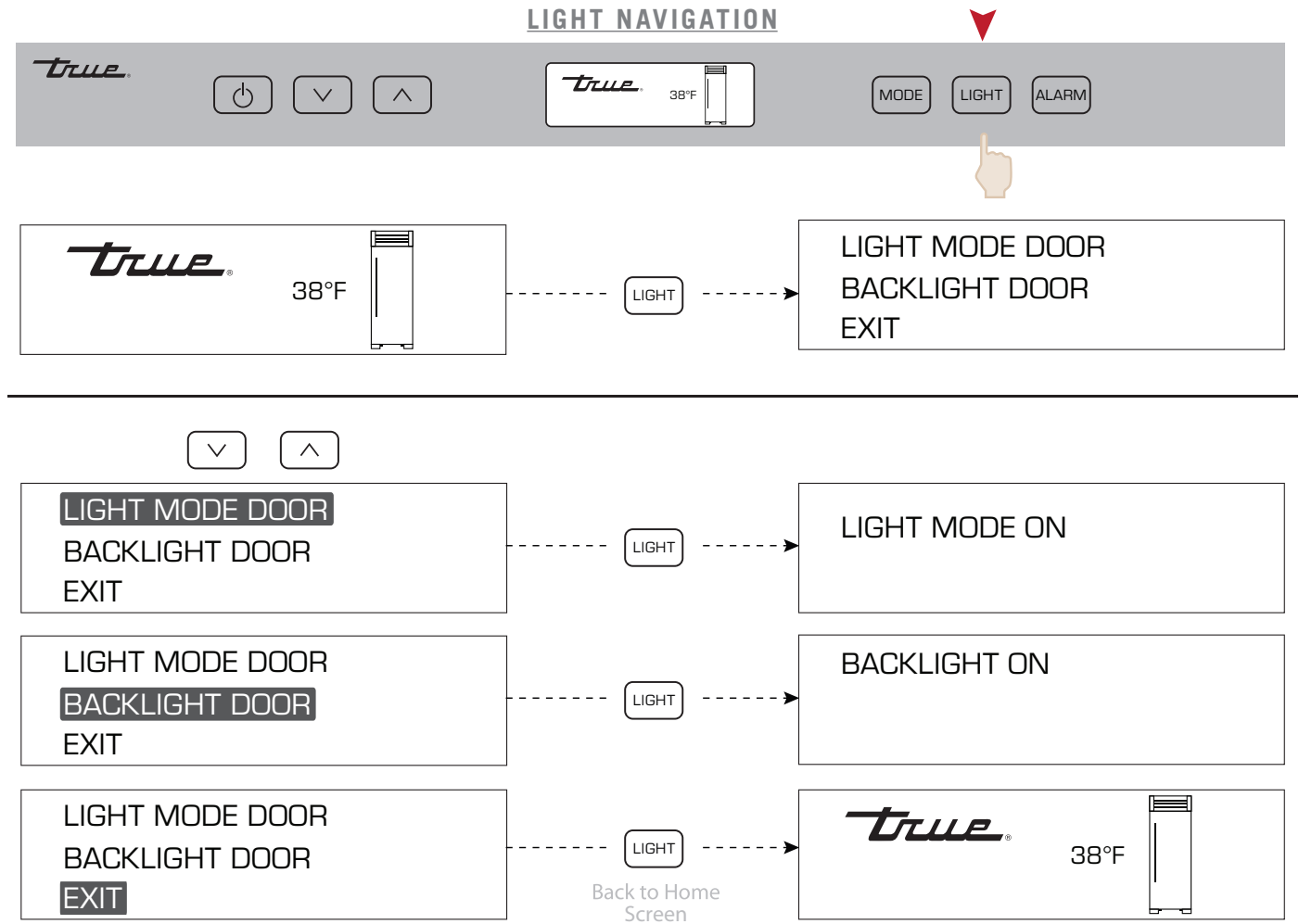

ALARM NAVIGATION (DOOR AJAR ALARM FEATURE ON/OFF)

All Residential Series units are equipped with a door ajar alarm feature. To enable the door ajar alarm, press the ALARM key on the control panel and “DOOR ALARM IS ON” will appear in the LCD indicating the alarm is enabled. With the alarm enabled, the notification icons will appear and an audible alarm will beep continuously whenever a door is left open for more than 5 minutes. To disable the door ajar alarm, press the ALARM key again and “DOOR ALARM IS OFF” will appear in the LCD.

ALARM NAVIGATION

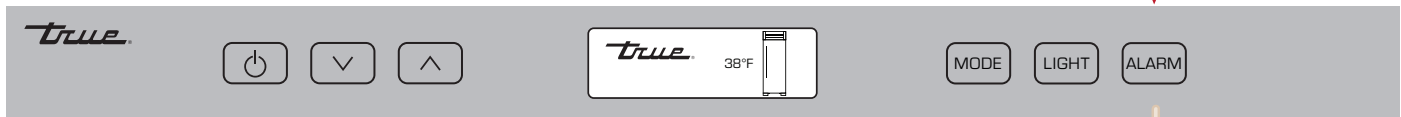

*TO STOP ALARM BUZZER PRESS

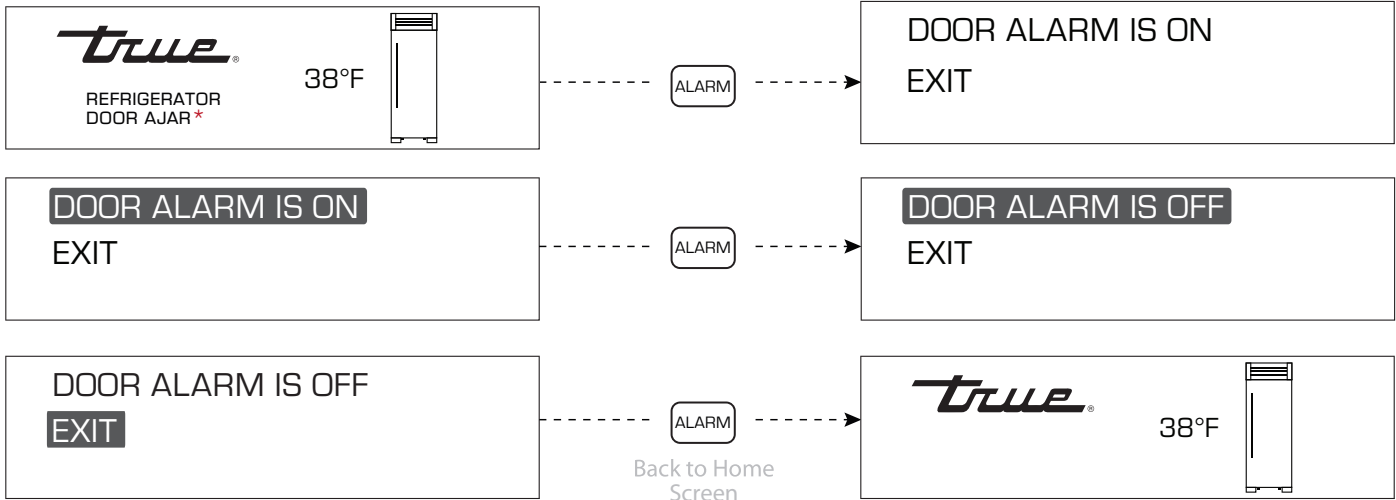

NOTIFICATION ALERTS

The diagrams on these pages illustrate what a customer may see in the LCD if the appliance needs attention.

NOTIFICATION ALERTS

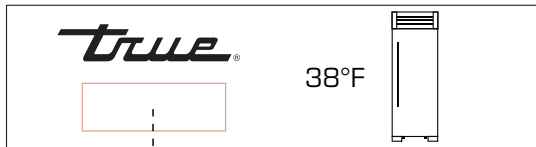
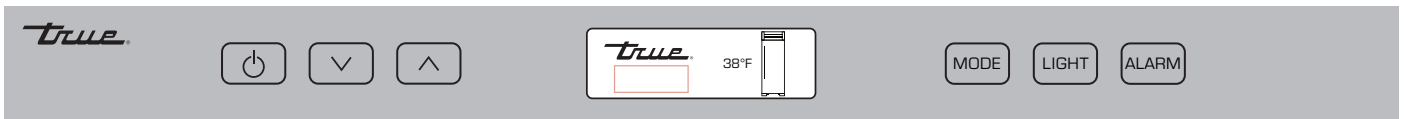

- DEFROST
- HIGH TEMP
- SHOWROOM MODE
- COMMUNICATION ERROR
- SERVICE REQUIRED
- DOOR ALARM

SHOWROOM MODE



When in Showroom Mode all cooling and defrosting functions are disabled, but the lighting system and door ajar alarm system remain operational, and the LCD will show the set-points.

NOTES:

- For demonstration purposes, all the navigation menus are display only and inactive.

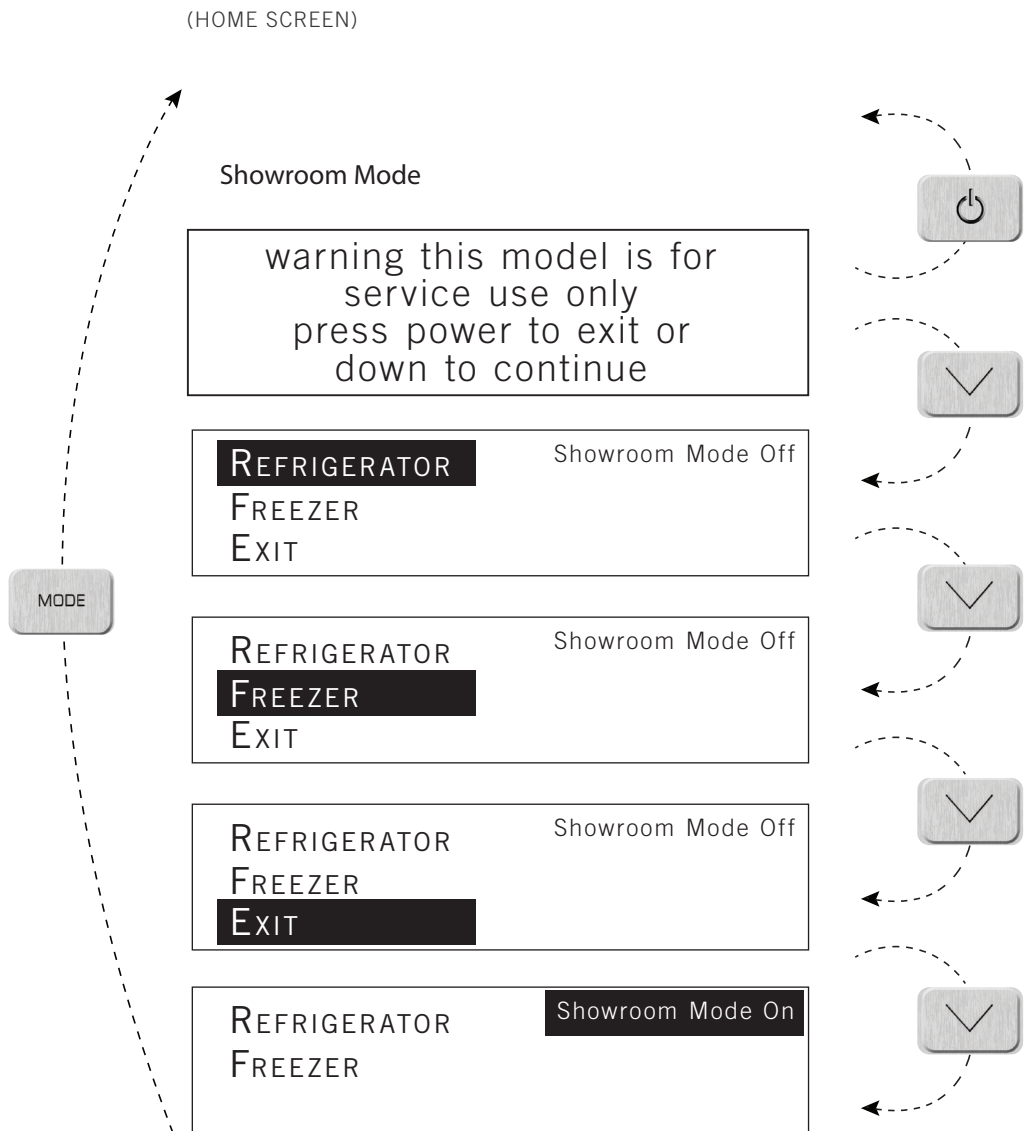

DUAL ZONE

BASIC ELECTRONIC OPERATIONS

SHOWROOM MODE



BASIC ELECTRONIC CONTROL OPERATIONS

UNIT ON/OFF

All units are shipped in ON Mode. When electricity is supplied to the appliance, a short power up diagnostics test is initiated followed by one audible beep, the lights energizing and temperature readings appearing in the LCD.

HOME SCREEN ON / OFF

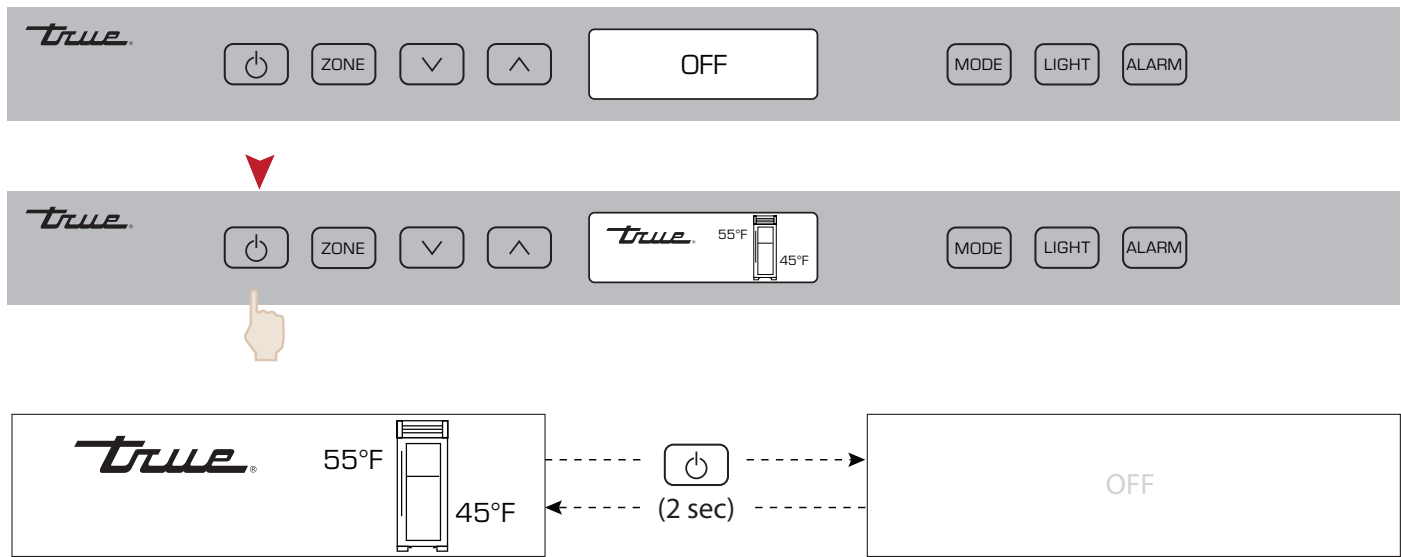

PLEASE NOTE THAT THOUGH POSSIBLE TO DISPLAY TEMPERATURES IN FAHRENHEIT OR CELSIUS, IN MOST CASES FAHRENHEIT READINGS ARE SHOWN IN THIS MANUAL.

TEMPERATURE ADJUSTMENT

To adjust set-point, press the ZONE button to highlight the zone for adjustment. Once the zone is highlighted, press DOWN or UP key on the control panel in multiple key strokes until the desired set-point is achieved. Each key stroke equals a one degree change and is accompanied by an audible beep. When the desired set-point is reached, press the ZONE button to return to “HOME” screen.

NOTES:

- THE TEMPERATURE RANGES FROM 40°F (4.4°C) TO 65°F (18.3°C) IN EITHER SECTION OF THE UNIT
- INITIAL FACTORY SET-POINTS ARE 55°F (12.7°C) IN THE UPPER ZONE AND 45°F (7.2°C) IN THE LOWER ZONE.
- THE INITIAL STROKE OF THE UP OR DOWN KEY WILL CHANGE THE PREVIOUS SET-POINT BY ONE DEGREE.

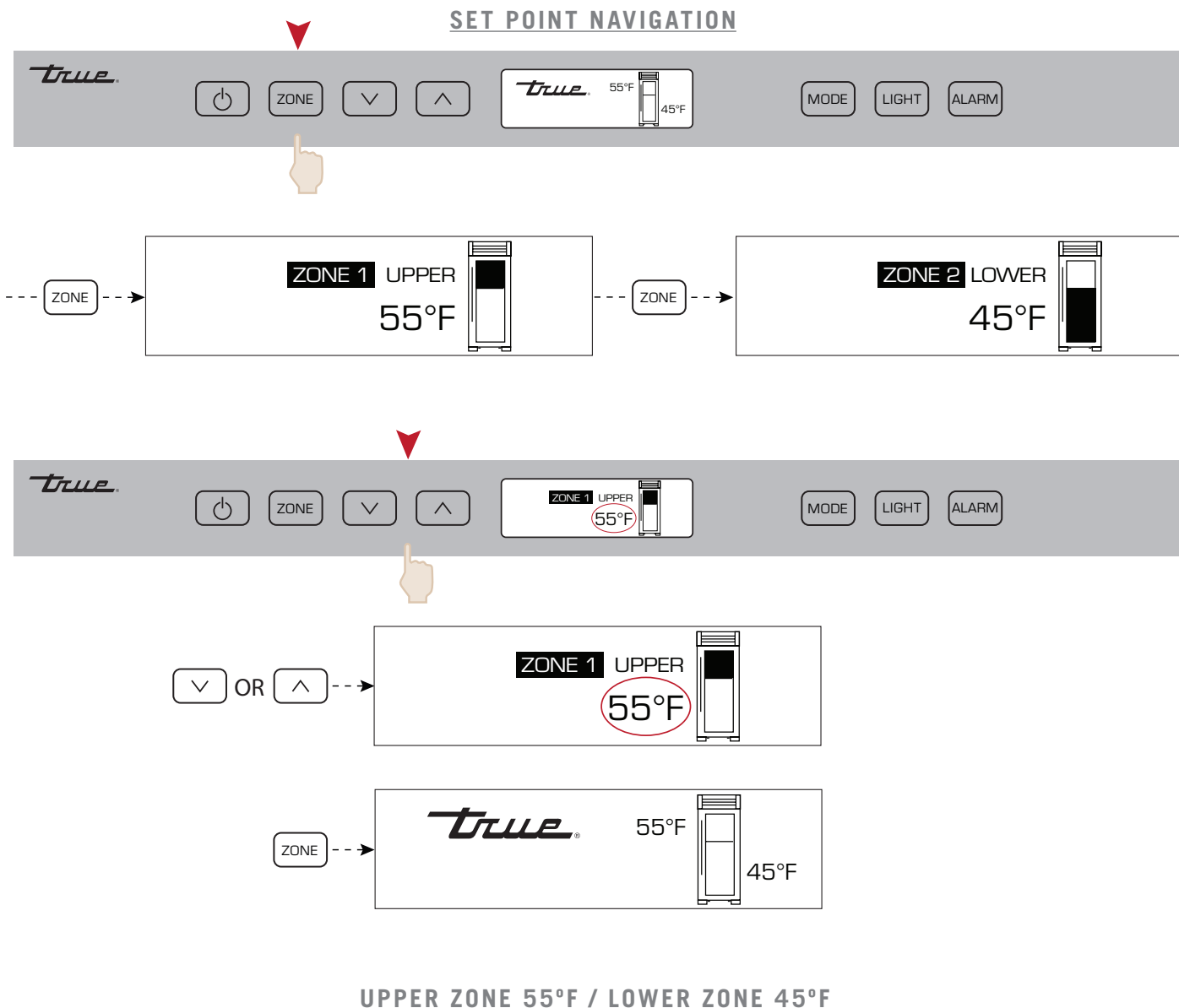

MODE NAVIGATION

The following pages illustrate unique customer input operations performed at the control panel. The input operations described are: **HOLIDAY MODE, TEMPERATURE UNIT SELECTION MODE AND VACATION MODE.**

NOTES: (HOLIDAY MODE)

- **SET-POINTS CANNOT BE CHANGED AND MANUAL DEFROST CANNOT BE INITIATED.**
- **THE FOLLOWING HOLDS TRUE IN ACCORDANCE WITH STAR-K REQUIREMENTS:**
 - Freezer defrosting functions will convert to a fixed time base sequence.
 - The compartment/zone thermistors will still detect cut-in and cut-out, which is the determining factor to start/stop the cooling process, but there will be a random sixteen (16) to twenty-one (21) second delay before cooling begins/ends.
 - The phrase "HOLIDAY MODE ACTIVE" in the LCD remains energized when the door is closed.

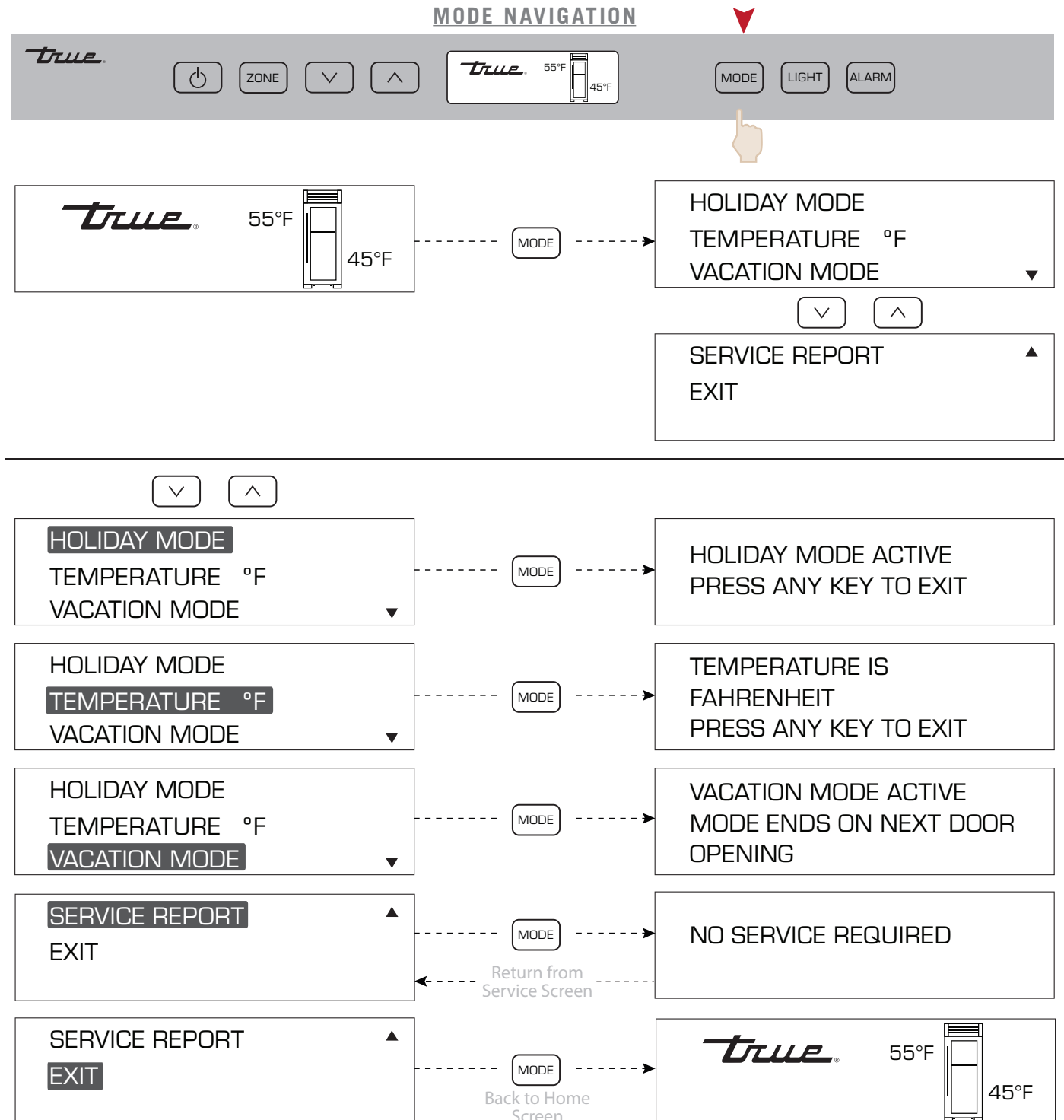

ACCENT LIGHTING SYSTEM

All models are equipped with an accent lighting system in the refrigerator and or freezer compartment(s). To change the accent lighting color, press the LIGHT key once until you see “CHANGE COLOR” press the LIGHT button once again to start  Lumina. Press the “LIGHT” button once again to lock in your desired color. DOOR or ON will appear in the LCD indicating the accent lights are enabled. With the accent lighting system ON, the LED’s will be energized and stay illuminated when the door is closed, in the DOOR position the lighting system will only be energized with the door opening.

COLOR CHANGE

To change colors of the LED’s, press the light button once until you see “CHANGE COLOR”. Press the “LIGHT” button once and release to start cycling through  Lumina. Press the “LIGHT” button again to hold the color option you desire.

LIGHT NAVIGATION

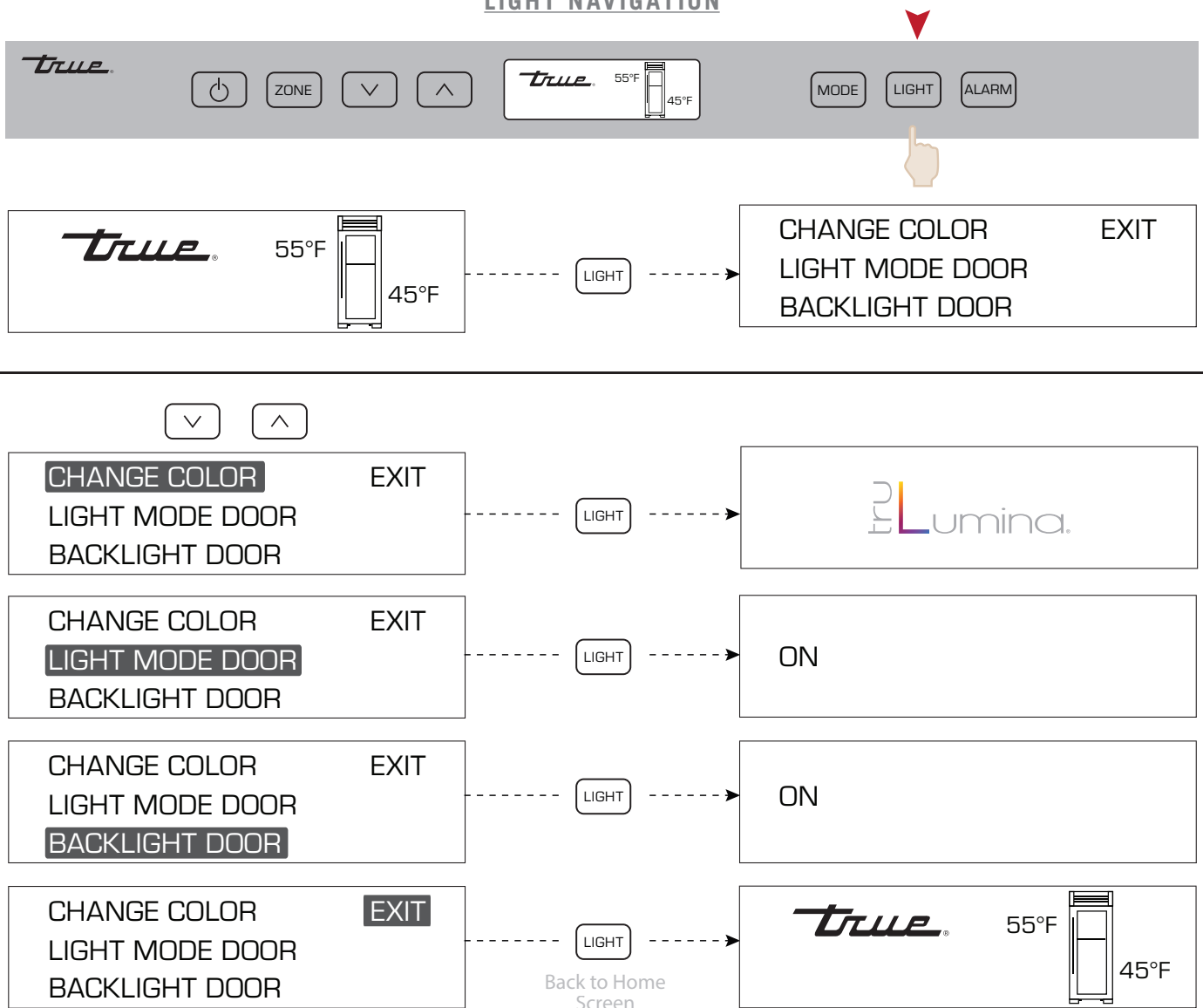

ALARM NAVIGATION (DOOR AJAR ALARM FEATURE ON/OFF)

All Residential Series units are equipped with a door ajar alarm feature. To enable the door ajar alarm, press the ALARM key on the control panel and “DOOR ALARM IS ON” will appear in the LCD indicating the alarm is enabled. With the alarm enabled, the notification icons will appear and an audible alarm will beep continuously whenever a door is left open for more than 5 minutes. To disable the door ajar alarm, press the ALARM key again and “DOOR ALARM IS OFF” will appear in the LCD.

ALARM NAVIGATION

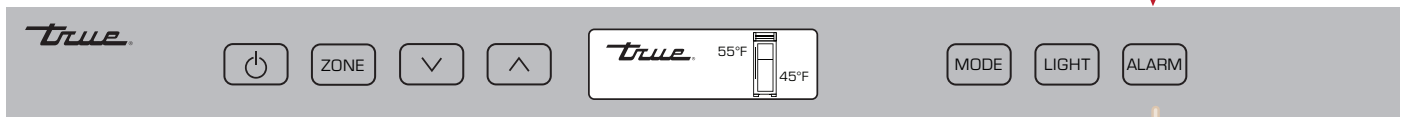

*TO STOP ALARM BUZZER PRESS 

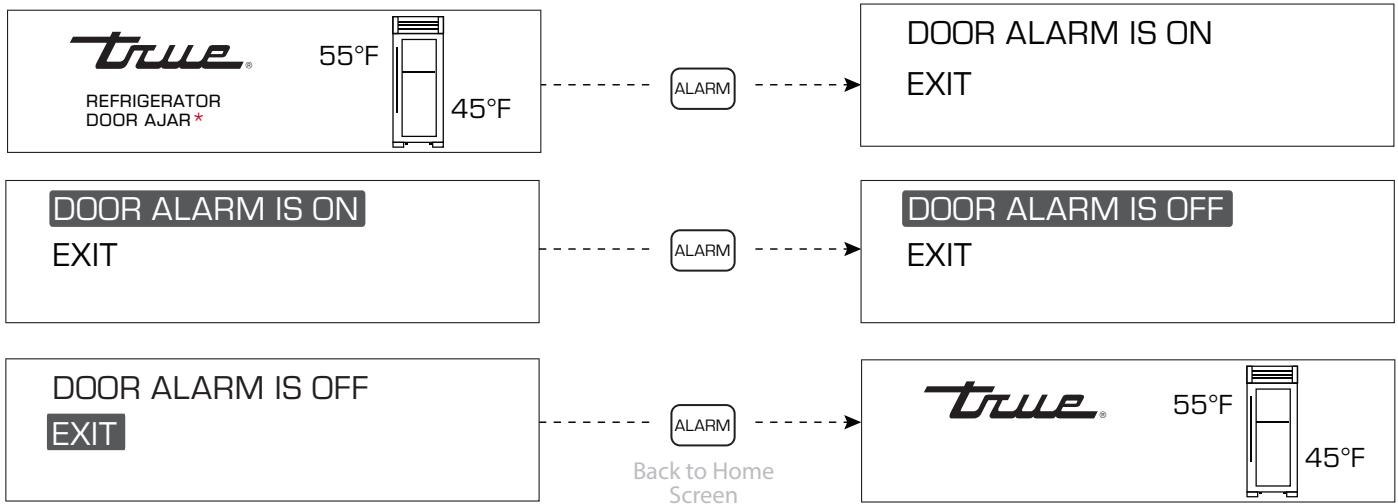

NOTIFICATION ALERTS

The diagrams on these pages illustrate what a customer may see in the LCD if the appliance needs attention.

NOTIFICATION ALERTS

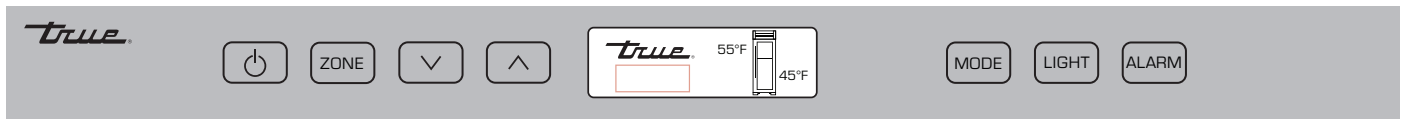

- DEFROST
- HIGH TEMP
- SHOWROOM MODE
- COMMUNICATION ERROR
- SERVICE REQUIRED
- DOOR ALARM
- ZONE 1 UPPER HIGH TEMP
- ZONE 2 LOWER HIGH TEMP

SHOWROOM MODE



When in Showroom Mode all cooling and defrosting functions are disabled, but the lighting system and door ajar alarm system remain operational, and the LCD will show the set-points.

NOTES:

- For demonstration purposes, all the navigation menus are display only and inactive.

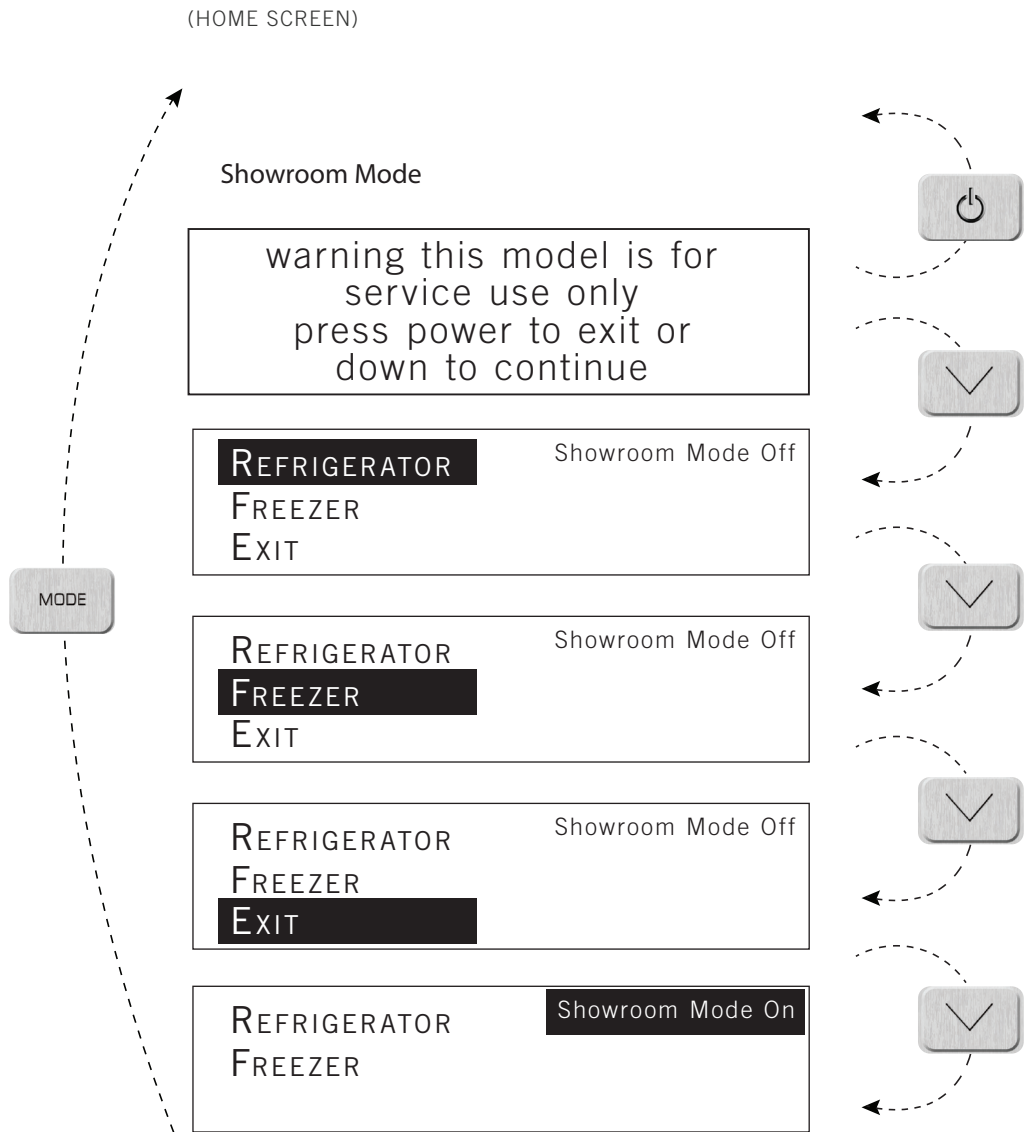

SHELVING

REFRIGERATOR STORAGE

FREEZER STORAGE

REMOVING THE DOORS

KICK PLATE INSTALLATION



SHELVING

All shelving and door bins come packaged inside the unit.



REFRIGERATOR STORAGE

GLASS SHELVES

Remove the top foam piece holding the glass shelves. Carefully remove shelves and set aside. Remove all other packing material. To install, insert glass shelf into the shelf standards on the back wall, with the front tilted upward, and then lower the front until it stops. To remove or adjust a glass shelf, tilt up, and then lift up and out.

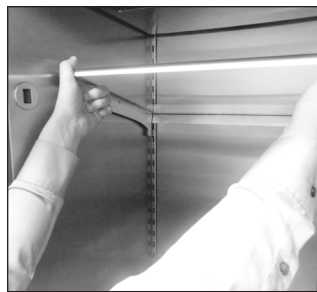

FINAL GLASS SHELF INSTALLATION

DOOR BINS

The door bins are located in the bottom drawer of the refrigerator. To install, push tabs into the slots in the door and slide downward until it stops. To remove or adjust a door bin, lift up and away from door back.

NOTE: BE CAUTIOUS OF PLACING TALL ITEMS IN TOP DOOR BIN, AS ITEMS MIGHT INTERFERE WITH UI CONTROL PANEL.

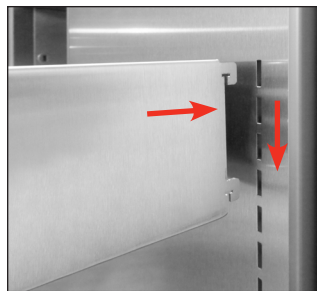

FINAL DOOR BIN INSTALLATION

DRAWERS

To remove a drawer, pull drawer forward until it stops. Use a Phillips screw driver to remove the two (2) screws securing the drawer to the slides, then lift the drawer up and out of unit. To reinstall, pull drawer slides all the way forward on unit, and then slide the drawer onto the slides until the hook on the back of the slide is over top of the drawer, reinstall the screws using the Phillips screw driver.



FREEZER STORAGE

WIRE SHELVES

Remove the top foam piece holding the wire shelves. Carefully remove shelves and set aside. Remove all other packing material. To install, insert wire shelf into the shelf standards on the back wall, with the front tilted upward, and then lower the front until it stops. To remove or adjust a wire shelf, tilt up, and then lift up and out.

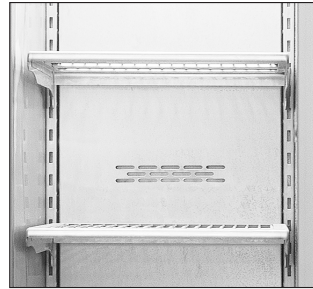

FINAL WIRE SHELF INSTALLATION

WIRE BASKETS

To remove a basket, pull drawer forward until it stops. Use a Phillips screw driver to remove the two (2) screws securing the basket to the slides, then lift the basket up and out of unit. To reinstall, pull drawer slides all the way forward on unit, and then slide the basket onto the slides until the hook on the back of the slide is over top of the rails, reinstall the screws using the Phillips screw driver.

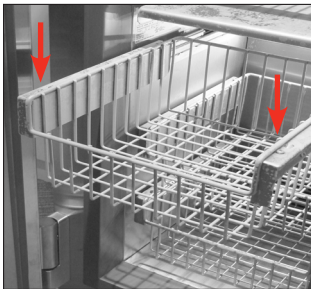

REMOVING THE DOORS

Open the top louver grill. With the door open at 90 degrees, lift the door straight up and out of the hinges. To re-install, hold the door 90 degrees to the opening and align hinge posts to the hinges. Lower the door into place.



KICK PLATE INSTALLATION

The kick plate is shipped with the unit but not attached to allow access to level the unit. Once the unit is level, the kick plate attaches to the front, bottom of the unit with magnets located on the left and right.

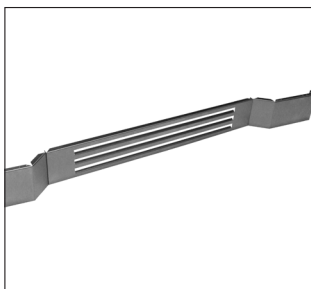

KICK PLATE

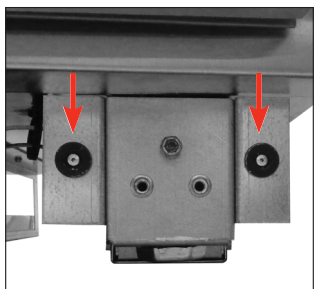

KICK PLATE MAGNETS



INSTALLED KICK PLATE

STAINLESS STEEL EQUIPMENT CARE AND CLEANING

GENERAL MAINTENANCE

CONDENSATION

DATA TAG

CONTACT US

WARRANTY STATEMENT



STAINLESS STEEL EQUIPMENT CARE AND CLEANING

CAUTION: DO NOT USE ANY STEEL WOOL, ABRASIVE OR CHLORINE BASED PRODUCTS TO CLEAN STAINLESS STEEL SURFACES.

STAINLESS STEEL OPPONENTS

There are three basic things which can break down your stainless steel's passivity layer and allow corrosion to rear its ugly head.

1. Scratches from wire brushes, scrapers, and steel pads are just a few examples of items that can be abrasive to stainless steel's surface.
2. Deposits left on your stainless steel can leave spots. You may have hard or soft water depending on what part of the country you live in. Hard water can leave spots. Hard water that is heated can leave deposits if left to sit too long. These deposits can cause the passive layer to break down and rust your stainless steel.
All deposits left from food prep or service should be removed as soon as possible.
3. Chlorides are present in table salt, food, and water. Household and industrial cleaners are the worst type of chlorides to use.

STAINLESS STEEL CLEANING AND RESTORATION

Do not use stainless steel cleaners or similar solvents to clean plastic or powder-coated parts. Instead, use warm soapy water.

- For routine cleaning and removal of grease and oil, apply white vinegar, ammonia, or any good commercial detergent* with a soft cloth or sponge.
- Stainless steel polish (e.g., Zep® Stainless Steel Polish, Weiman® Stainless Steel Cleaner & Polish, Nyco® Stainless Steel Cleaner & Polish, or Ecolab® Ecoshine®) and olive oil can act as a barrier against fingerprints and smears.
- Degreasers* (e.g., Easy-Off® Specialty Kitchen Degreaser or Simple Green® Industrial Cleaner & Degreaser) are excellent for removal of grease, fatty acids, blood and burnt-on foods on all surfaces.

- For restoration/passivation or removing stubborn stains and discoloration, Brillo® Cameo®, Zud® Cleanser, Ecolab® Specifax™ First Impression® Metal Polish, Sheila Shine, or talc can be applied by rubbing in the direction of the polish lines.

**Do not use detergents or degreasers with chlorides or phosphates.*

NOTE: The use of proprietary names is intended for example only and does not constitute or imply an endorsement. Omission of proprietary cleansers from this list does not imply inadequacy.

8 TIPS TO HELP PREVENT RUST ON STAINLESS STEEL MAINTAIN THE CLEANLINESS OF YOUR EQUIPMENT

Avoid build-up of hard stains by cleaning frequently. Use cleaners at the recommended strength (alkaline chlorinated or non-chloride).

USE THE CORRECT CLEANING TOOLS

Use non-abrasive tools when cleaning your stainless steel products. The stainless steel's passive layer will not be harmed by soft cloths and plastic scouring pads.

CLEAN ALONG POLISHING LINES

Polishing lines ("grain") are visible on some stainless steels. Always scrub parallel to polishing lines when visible. Use a plastic scouring pad or soft cloth when you cannot see the grain.

USE ALKALINE, ALKALINE-CHLORINATED OR NON-CHLORIDE CLEANERS

While many traditional cleaners are loaded with chlorides, the industry is providing an ever increasing choice of non-chloride cleaners. If you are not sure of your cleaner's chloride content, contact your cleaner supplier. If they tell you that your present cleaner contains chlorides, ask if they have an alternative. Avoid cleaners containing quaternary salts, as they can attack stainless steel, causing pitting and rusting.

RINSE

When using chlorinated cleaners, you must rinse and wipe dry immediately. It is better to wipe standing cleaning agents and water as soon as possible. Allow the stainless steel equipment to air dry. Oxygen helps maintain the passivity film on stainless steel.

NEVER USE HYDROCHLORIC ACID (MURIATIC ACID) ON STAINLESS STEEL

Even diluted, hydrochloric acid can cause corrosion, pitting and stress corrosion cracking of stainless steel.

WATER TREATMENT

To reduce deposits, soften hard water when possible. Installation of certain filters can remove corrosive and distasteful elements. Salts in a properly maintained water softener can also be to your advantage. Contact a treatment specialist if you are not sure of the proper water treatment.

REGULARLY RESTORE & PASSIVATE STAINLESS STEEL

Stainless steel gets its stainless properties from the protective chromium oxides on its surface. If these oxides are removed by scouring, or by reaction with harmful chemicals, then the iron in the steel is exposed and can begin to oxidize, or rust. Passivation is a chemical process that removes free iron and other contaminants from the surface of stainless steel, allowing the protective chromium oxides to re-form.

GENERAL MAINTENANCE

Keeping the condenser coil clean will minimize required service and lower electrical cost. The condenser coil is accessible from the front.



The condenser coil should be cleaned by removing dust and other build-up from the tube assembly with vacuum or a cleaning rag. When properly cleaned you should be able to see through the tube assembly. Warranty does not cover cleaning the condenser coil.

CONDENSATION

Leaving the door open for a long period of time or a unit that is running with little to no product inside may also cause excessive condensation.

DATA TAG

Please have your model number and seven-digit serial number on hand so we can better assist you with your service- or parts-related inquiries. These numbers are on the data tag, located on the left hand side wall by the pull out wire basket in freezers, and the upper drawer in refrigerators.

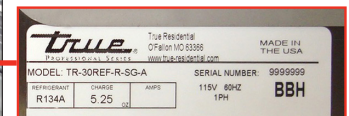

CONTACT US

CUSTOMER SERVICE

Phone: 888-616-8783
www.true-residential.com

WARRANTY DEPARTMENT

Phone: 844-849-6179
trueresidentialwarranty@truemfg.com

SERVICE DEPARTMENT

Phone: 844-746-9423
service@truemfg.com

TRUE RESIDENTIAL® SERIES LIMITED WARRANTY STATEMENT

LIMITED 30 DAY COSMETIC WARRANTY

Stainless steel doors, handles, and shelves are warranted to be free from defective materials or workmanship for a period of thirty (30) days from the date of original retail purchase. Any defects must be reported to the selling dealer within thirty (30) days from the date of original retail purchase. This limited warranty excludes any type of freight / concealed damage.

THREE-YEAR PARTS & LABOR WARRANTY *For units purchased after Feb 1, 2013.

TRUE warrants to the original purchaser of every new TRUE refrigerated unit, the cabinet and all parts thereof, to be free from defects in material or workmanship under normal and proper use and maintenance as specified by TRUE and upon proper installation and start-up in accordance with the instruction packet supplied with each TRUE unit. TRUE's obligation under this warranty is limited to a period of three (3) years from the date of original installation or thirty nine (39) months after shipment date from TRUE, whichever occurs first.

SIX-YEAR SEALED SYSTEM WARRANTY - PARTS & LABOR *For units purchased after Feb 1, 2013.

TRUE warrants its hermetically sealed system: compressor, evaporator coil, condenser coil, drier, metering device and connecting tubing to be free from defects in both material and workmanship under normal and proper use and maintenance service for a period of six (6) years from the date of original installation but not to exceed six (6) years and three (3) months after shipment from the manufacturer, whichever occurs first.

SEVEN THROUGH TWELVE-YEAR SEALED SYSTEM WARRANTY - PARTS ONLY *For units shipped from True after Feb 1, 2017 and REGISTERED via True's Product Registration Page – TRUE warrants its hermetically sealed system: compressor, evaporator coil, condenser coil, drier, metering device and connecting tubing to be free from defects in both material and workmanship under normal and proper use and maintenance service period of Twelve (12) years from the date of original installation but not to exceed twelve (12) years and three (3) months after shipment from the manufacturer, whichever occurs first. Product must be registered with True to qualify for this warranty. Factory seconds and clear Ice machines are excluded from this warranty.

TERMS APPLICABLE TO EACH WARRANTY

Any part covered under the above warranties that is determined by TRUE to have been defective within the time frame is limited to the repair or replacement, including labor charges, of defective parts or assemblies. The labor warranty shall include standard straight time labor charges only and reasonable travel time, as determined by TRUE.

WARRANTY CLAIMS

All claims for labor or parts must be made directly through TRUE. All claims should include: model number and serial number of cabinet, proof of purchase, and date of installation. In case of warranted compressor, the compressor model tag must be returned to TRUE along with the above listed information.

WHAT IS NOT COVERED BY THIS WARRANTY

TRUE's sole obligation under this warranty is limited to either repair or replacement of parts, subject to the additional limitations below. This warranty neither assumes nor authorizes any person to assume obligations other than those expressly covered by this warranty.

NO CONSEQUENTIAL DAMAGES. TRUE is not responsible for economic loss, profit loss; or special, indirect or consequential damages, including without limitation, losses or damages arising from food or product spoilage claims whether or not on account or refrigeration failure.

WARRANTY IS NOT TRANSFERABLE. This warranty is not assignable and applies only in favor of the original purchaser/user to whom delivered. Any such assignment or transfer shall void the warranties herein made and shall void all warranties, express or implied, including any warranty or merchantability or fitness for a particular purpose.

IMPROPER USAGE. TRUE assumes no liability for parts or labor coverage for component failure or other damages resulting from improper usage or installation or failure to clean and/or maintain product as set forth in the warranty packet provided with the unit.

ALTERATION OR NEGLIGENCE. TRUE is not responsible for the repair or replacement of any parts that TRUE determines have been subjected after the date of manufacture to alteration, neglect, abuse, misuse, accident, damage during transit or installation, fire, flood, or act of God.

IMPROPER ELECTRICAL CONNECTIONS. TRUE is not responsible for the repair or replacement of failed or damaged components resulting from electrical power failure, high or low voltage, use of extension cords, or improper grounding of the unit.

YOUR RIGHTS UNDER STATE LAW.

This warranty gives you specific legal rights and you may have other rights that vary from state to state. Some states do not allow the exclusion or limitation of consequential damages or a limitation on how long an implied warranty lasts, so the above exclusion or limitation may not apply to you.

OUTSIDE U.S./CANADA. This warranty does not apply to, and TRUE is not responsible for, any warranty claims made on products sold or used outside the United States or Canada.

SUBMIT WARRANTY CLAIMS TO: *True Residential*
2001 East Terra Lane
O'Fallon MO 63366
TrueResidentialWarranty@truemfg.com

MS • 5/17 • API2335

CONTACT US
www.true-residential.com
toll free (888)616-8783



TP - MISC_2248 - 6.19



212530