

BUILT-IN WINE CELLAR 24"



CODE ID

F71BW24O1-R



RIGHT DOOR







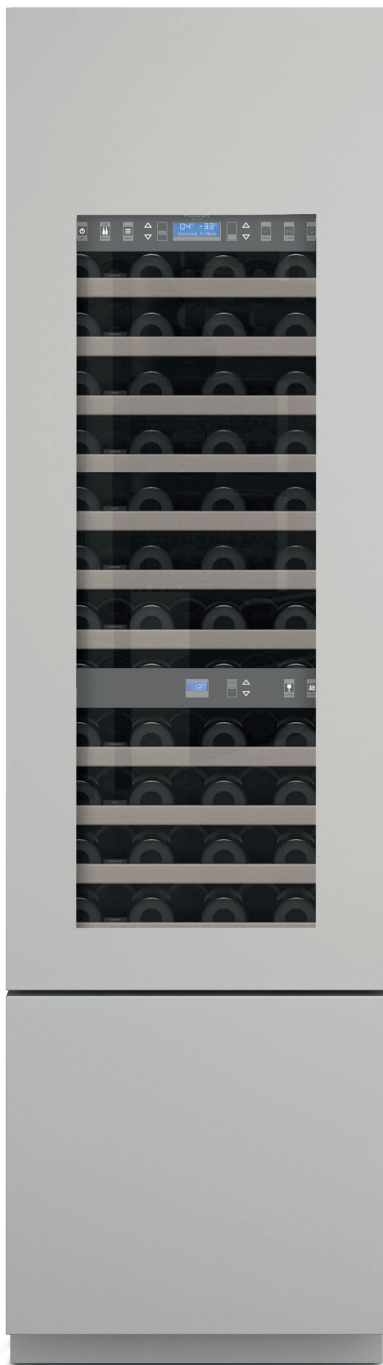

CODE ID

F71BW24O1-L



LEFT DOOR



-  Deep-freezing
-  Hot air ventilation
-  Rapid Deep Freezing
-  LED lighting
-  Noise Level 41 (dB)
-  Integrated Installation
-  Holiday Mode
-  Triple Panel Door
-  54 Bottles Capacity

WINE CELLAR

Cave Storage Compartment,
Natural Wood Shelves, for 36 bottles
Wine Celler Compartment,
Natural Wood Shelves, for 18 bottles
TriplePlay Refrigeration
Total No Frost
LED Lighting
Brilliant white aluminium interior
Fresh Zone Bottom Drawer
Overlay Panel

NOTE:

Handle kit: Distinto Fridge and Wine Cellar handles are to be supplied by installer

DISTINTO

24" BUILT-IN WINE CELLAR

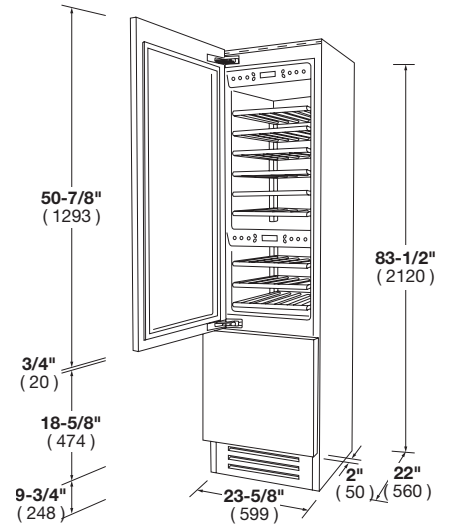

CODE ID	LEFT DOOR	F71BW2401-L 24" BUILT-IN WINE CELLAR	F71BW2401-R 24" BUILT-IN WINE CELLAR	RIGHT DOOR
Series and Finish	Series 700 - Distinto - Overlay Panel			
PERFORMANCES/CAPACITY				
Noise Level db			41	
Riserva Compartment capacity (bottles)			36	
Wine Cellar Compartment capacity (bottles)			18	
Fresh Zone Bottom-Drawer capacity (cbft)			2	
FEATURES				
Riserva storage compartment				
Natural wood shelves			6	
Wine Cellar Compartment				
Natural wood shelves			3	
Fresh Zone Bottom-Drawer				
White Painted Drawers			1	
Internal Drawers			1	
LED lighting			•	
Glass door			•	
Equipment				
TriplePlay Refrigeration			•	
No Frost			•	
Fresh Zone			•	
TruPivot hinges			•	
DIMENSIONS/WEIGHT				
Width in	23 - 5/8"	600 mm)		
Height in	83 - 1/2"	(2121 mm)		
Depth without handle in	24"	(610 mm)		
Minimum niche height in	84"	(2134 mm)		
Door clearance in	46"	(1168 mm)		
Door opening angle				105°
Net Weight	386 lbs	(175 kg)		
POWER / RATINGS (115 V, 60 HZ)				
Watts / Amps	472W - 4.1A			
Power Cable	Nema 5-15P			
INSTRUCTIONS FOR USE				
Use & Care Manual / Installation Manual	English / French / Spanish			