

# SCIROCCO LUX

DOWN DRAFT



## INNOVATIVE AND SLEEK

Positioned next to the cooktop this downdraft hood is in the ideal place for efficient extraction. Additionally, the LED light bar illuminates the cooking area in front of the Scirocco Lux when in use.

## AVAILABLE MODELS

Model #	FUN #	Size / Color	Motor Class (CFM)
<b>SCLX3015BKNB-B</b>	340.0481.313	30" Blk Glass w/SS	No Blower
<b>SCLX3615BKNB-B</b>	110.0476.866	36" Blk Glass w/SS	No Blower

Blowers	FUN #	
<b>IBDD600-B</b>	113.0477.129	Internal Blower 600 CFM PRO
<b>RB900</b>	113.0176.625	Remote Blower 900 CFM - Requires WIREBOXSCLX
<b>RB1200</b>	113.0176.626	Remote Blower 1200 CFM - Requires WIREBOXSCLX
<b>AXP250</b>	133.0661.354	In-Line Blower 735 CFM - Requires WIREBOXSCLX & FLANGE10



THE SCIROCCO LUX DOWN DRAFT HOOD BOASTS AN **ELEGANT** AND DISCREET DESIGN AS WELL AS **EXCELLENT** EXTRACTION TECHNOLOGY.



# SCIROCCO LUX

DOWN DRAFT



MODEL	FUN #	SIZE/MATERIAL	MOTOR CLASS
<b>SCLX3015BKNB-B</b>	340.0481.313	30" Blk Glass w/SS	No Blower
<b>SCLX3615BKNB-B</b>	110.0476.866	36" Blk Glass w/SS	No Blower

FEATURES		PERFORMANCE		ACCESSORIES
<b>Ducting</b>		<b>Motor</b>		<b>MUDAMPER6</b>
Type	Ducted/Ductless with DUCTSCIR	No. of Fan Speeds	4	6" Make-up Air Kit
Duct Size	Vari-Duct - 6" Round Internal 10" Round Remote	Motor Class	PRO - 3 Options	<b>MUDAMPER8</b>
Multiple Ducting	Yes	Perimeter Aspiration	Yes	8" Make-up Air Kit
<b>Lighting</b>		Reversible Motor	Yes	<b>MUDAMPER10</b>
Type	Energy-Efficient LED	<b>Display</b>		10" Make-up Air Kit
# of Bulbs	Light Bar - 2 Level	Controls	Electronic Soft Touch Controls	<b>DUCTSCIR</b>
<b>Grease Filters</b>		Intensive Speed	10 Minutes	Ductless Conversion Kit
Filter Type	Mesh	Delay Shut-off	30 Minutes	<b>REMORIG</b>
Dishwasher Safe	Yes	<b>Other</b>		Wireless Remote Control
Anti-Pollution Mode	24 Hour	ADA Compliant	With Remote Control	<b>WIREBOXSCLX</b>
		Remote Control	Purchase Separately	Wire Box for Remote & In-Line Blowers
		Power Cord	Included	<b>CFMRED</b>
				CFM Reducer Kit 300 CFM
				<b>CFMRED2</b>
				CFM Reducer Kit 400 CFM
				<b>FLANGE10</b>
				Required for AXP250
				<b>FLANGE3</b>
				10" Round to 3 1/4" x 10" Flange

## DIMENSIONAL DRAWINGS

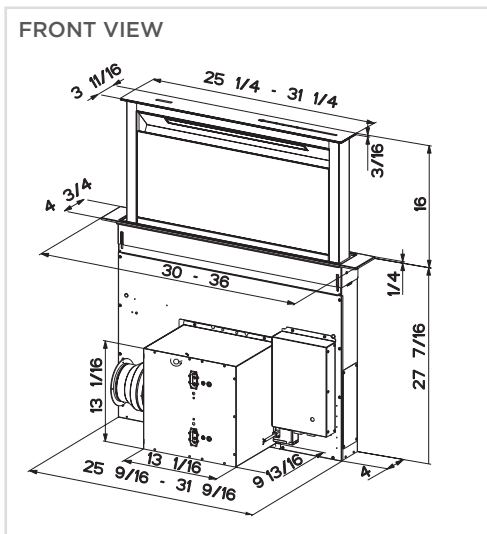

Rev2 722